

# McKenzie Occasional Tables

Assembly Instructions

**AFGAC = Glazed Antique Cherry finish**

**AFCAF = Caffè finish**

Model #

**3500AFGAC;**

**3500AFCAF**

**McKenzie Chair Side Table**



**3502AFGAC;**  
**3502AFCAF**  
**McKenzie Entry Table**

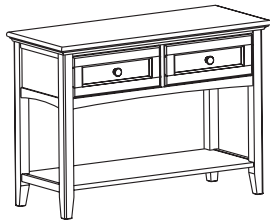

**3503AFGAC;**  
**3503AFCAF**  
**McKenzie Sofa Table**

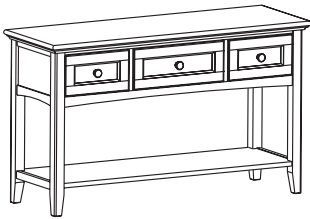

**Congratulations!**

*This fine piece of furniture will make a gorgeous addition to your home. For the best results, read the Assembly Instructions before you begin your project.*

## **IMPORTANT NOTES:**

- For normal household use only. **Not** recommended to use this product in a commercial setting.
- Unload items before you move this unit.
- Do not overload the drawer(s) or shelf.
- Before you load or move this unit, tighten all screws and supports.
- Before you begin your project, completely read the Assembly Instructions.
- Store this item: 1- in its box; 2- in a dry place; 3- in temperatures that range from 40°F to 90°F (not on a cold and possibly damp cement floor).
- Periodically inspect your furniture for any loose glue joints, screws or any other problem that might affect the stability of your furniture. Tighten or repair as needed.

**DESIGN SUBJECT TO CHANGE WITHOUT NOTICE.**



**CALL US FIRST!** *Do not return this item to the store.*

**Service Policy:** We will replace any part that is defective, missing or damaged during assembly. For a replacement part, contact Whittier Wood Products customer service department by phone, fax, mail or email.

**Hours:** Our friendly customer service staff can be reached Monday-Friday 7:00 a.m. to 5:00 p.m. (Pacific Time). You may leave a message 24 hours a day, seven days a week.

**To Order:** Provide the furniture model number and finish (above the illustration of your unit), the part letter, production code, quantity needed, reason for replacement and your full name, address and telephone number.

*Parts ship from our Eugene, Oregon factory within one or two business days from the time we receive your request. Please allow five to ten business days for delivery.*

**800-653-3336** • Outside the U.S. or Canada: 541-687-0213 • Fax: 541-687-2060  
www.whittierwood.com • P.O. Box 2827 • Eugene, Oregon 97402, U.S.A.

**Whittier  
Wood**  
FURNITURE

P.O. Box 2827  
Eugene, OR 97402 USA











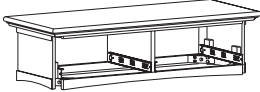

Production Code:

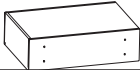
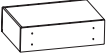
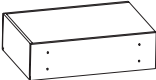
VN

08/11

# 3500AFGAC; 3502AFGAC; 3503AFGAC 3500AFCAF; 3502AFCAF; 3503AFCAF McKenzie Occasional Table — Parts List









Please identify the parts and check that quantities received match those on this list.  
If you need to replace a part, refer to the following letter and model name.

Part	Description	Quantity		
		3500AFGAC 3500AFCAF	3502AFGAC 3502AFCAF	3503AFGAC 3503AFCAF
A	Top Assembly 	1	1	1
B	Top (attached) 	1	1	1
C	Shelf Assembly 	1	1	1
D	Leg 	4	4	4
F	Drawer (inserted) 	1	2	0
G	Small Drawer (inserted) 	0	0	2
H	Large Drawer (inserted) 	0	0	1
I	Drawer Face (installed) 	1	2	0
J	Small Drawer Face (installed) 	0	0	2
K	Large Drawer Face (installed) 	0	0	1
L	20" Drawer Slides (installed)	1 set	0	0
M	14" Drawer Slides (installed)	0	2 sets	3 sets
N	#6 x 3/4" Philtruss Screw (inserted) 	6	12	18
O	#6 x 1/2" Philtruss Screw (inserted) 	6	12	18
P	Knob (attached) 	1	2	3
Q	#8 x 1-1/2" Machine Screw (installed) 	1	2	3

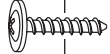
# 3500AFGAC; 3502AFGAC; 3503AFGAC 3500AFCAF; 3502AFCAF; 3503AFCAF

## McKenzie Occasional Table — Parts List continued

Please identify the parts and check that quantities received match those on this list.  
If you need to replace a part, refer to the following letter and model name.

Part	Description	Quantity		
		3500AFGAC 3500AFCAF	3502AFGAC 3502AFCAF	3503AFGAC 3503AFCAF
S	Adjustable Glide (inserted) 	4	4	4
T	#8 x 1-1/4" Pan Head Screw 	52 (48 inserted)	54 (50 inserted)	56 (52 inserted)
U	#8 x 7/8" LoProfile Screw (inserted) 	4	8	12
V	Wood Dowel (inserted) 	4	4	4
W	Insert Nut (inserted) 	8	8	8
X	5/16" Flat Washer 	8	8	8
Y	3/8" x 2-1/2" Hex Bolt 	8	8	8
ZA	1/4" x 20mm Insert Nut (inserted) 	4	4	4

3502 shown.

# 3500AFGAC; 3502AFGAC; 3503AFGAC 3500AFCAF; 3502AFCAF; 3503AFCAF McKenzie Occasional Table Assembly Instructions

Tools Required: Phillips Screwdriver, 9/16" or Adjustable Wrench

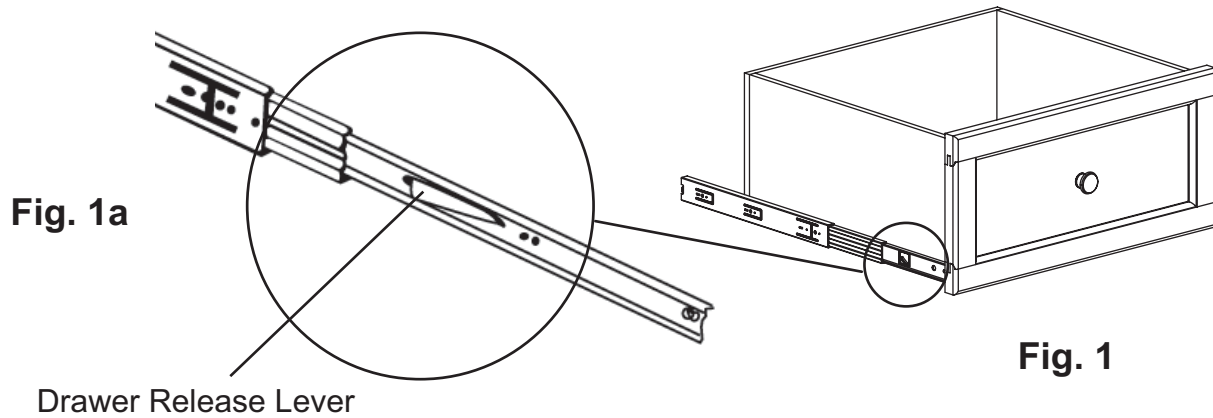

1. Remove the Drawers (F) from the Case (A). To remove the drawers, pull up on the left side of the Drawer Release Lever while pushing down on the right Drawer Release Lever. See Figure 1a. Note where each drawer came from to ensure correct installation.

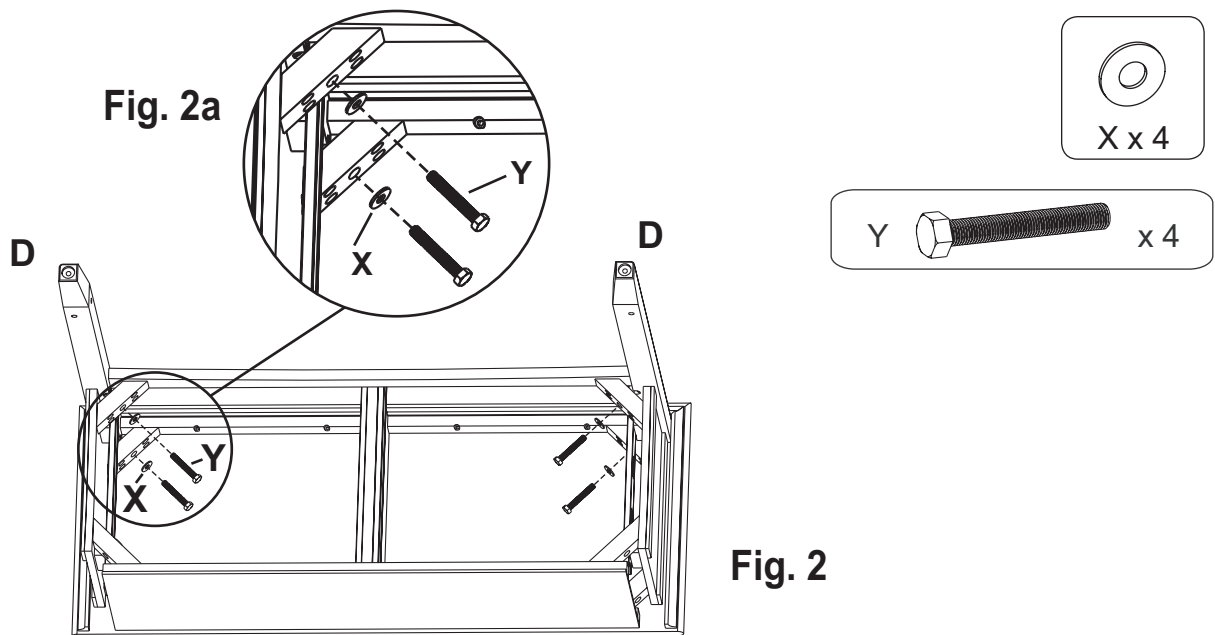

2. Turn the unit upside down on a clean, protected surface. Place two Legs (D) at the front corners of the Case (A) as shown in Figure 2. Face the drilled corners of the legs toward the Corner Blocks. Insert two 3/8" x 2-1/2" Hex Bolts (Y) with two Flat Washers (X) through the Corner Blocks and into the leg and securely fasten. See Figures 2 and 2a. Repeat for the second front leg.

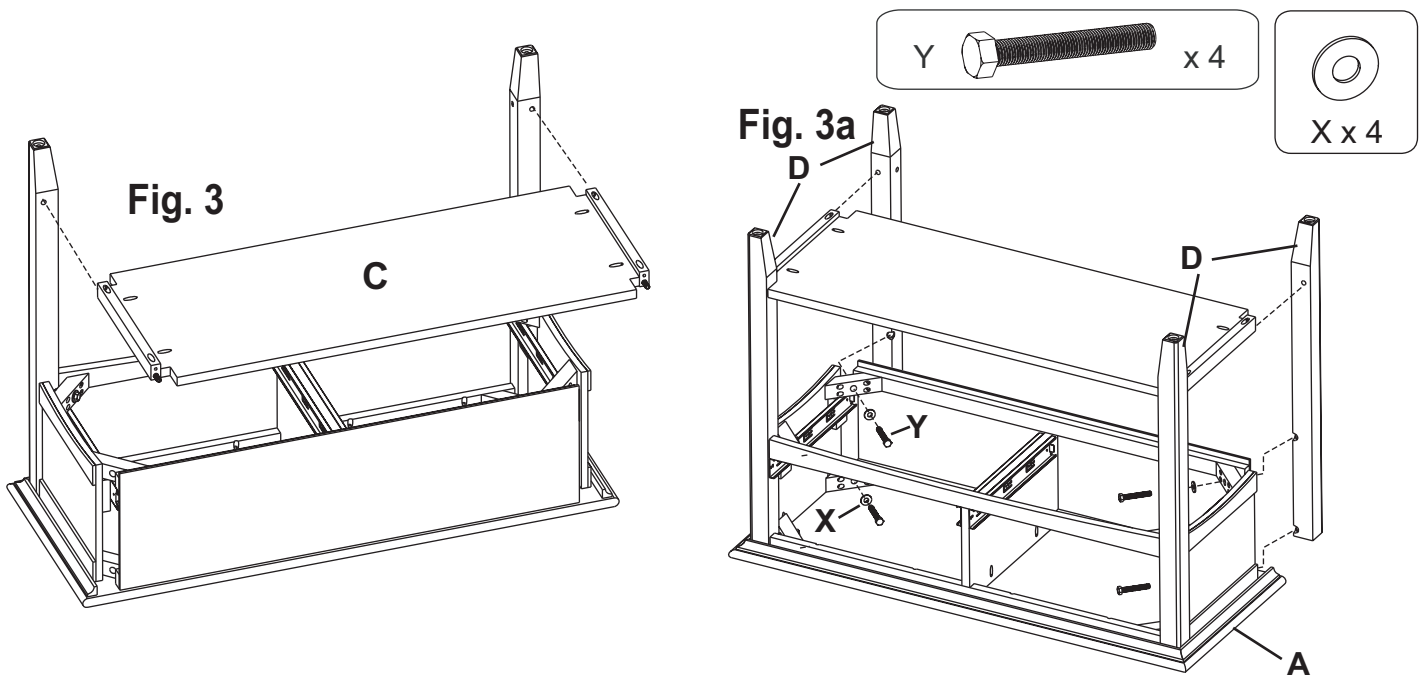

3. Insert the dowels in the Shelf (C) into the holes in the legs. See Figure 3. While holding the shelf stable, place a Leg (D) against the Case and Shelf so that the Insert Nut aligns with the Corner Block and insert the Dowel in the Shelf into the hole in the leg. Insert two 3/8" x 2-1/2" Hex Bolts (Y) with two Flat Washers (X) through the Corner Blocks and into the leg and securely fasten. See Figures 3 and 3a. Repeat for the final leg.

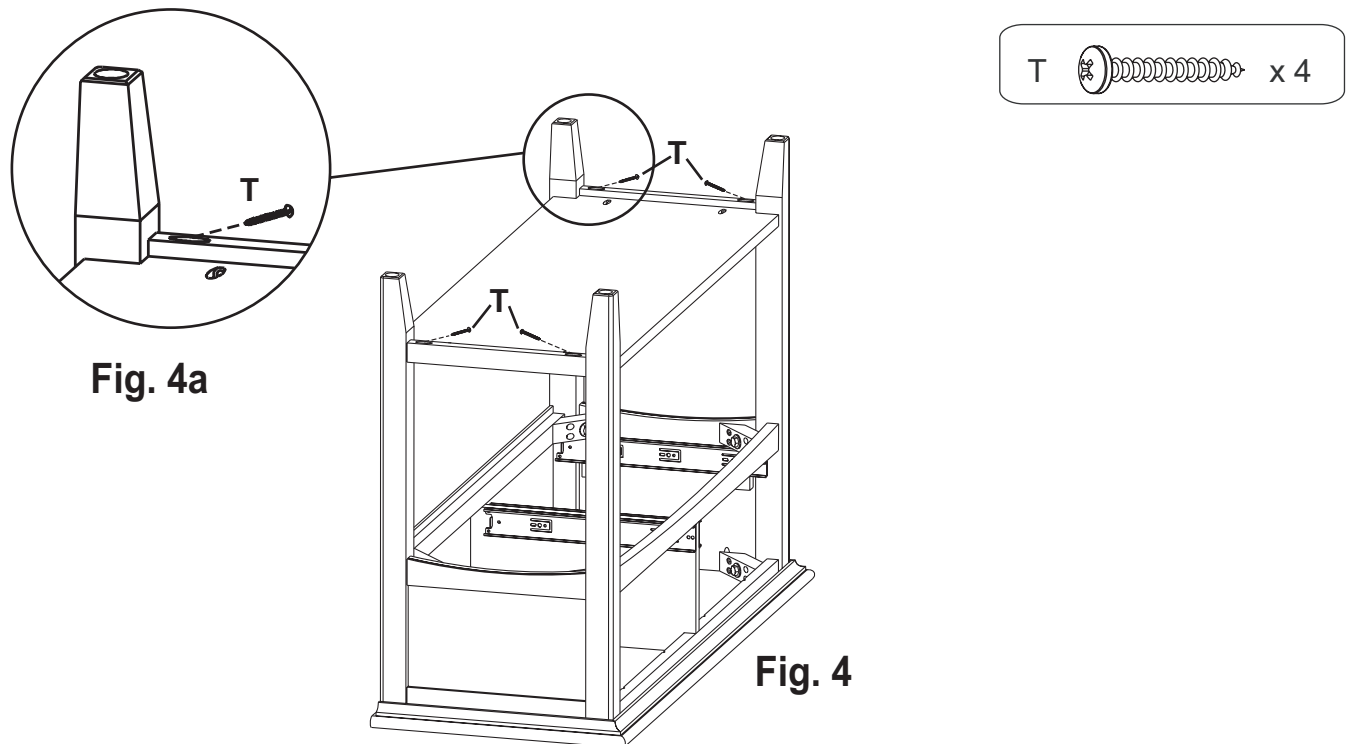

4. Using the pocket drilled holes as guides, secure the Shelf with four #8 x 1-1/4" Pan Head Screws (T). See Figures 4 and 4a.

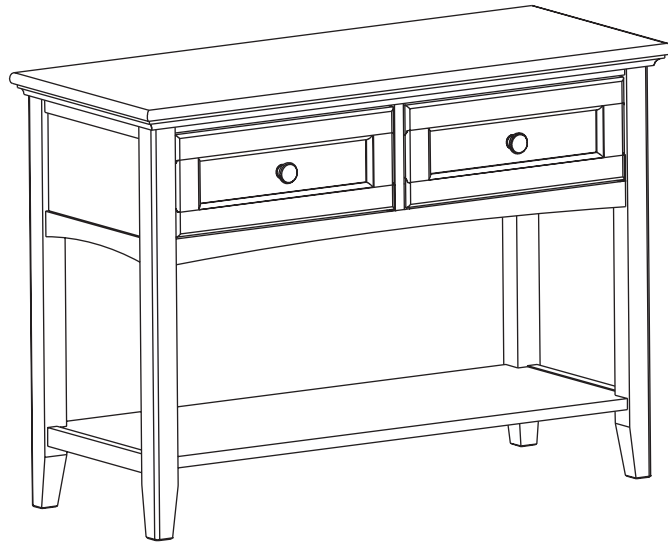

**Fig. 5**

5. Turn the table upright and insert the Drawers.

---

6. Place the table at its final destination. To level the table, rotate the Adjustable Glide (S) found at the bottom of each leg.