

Model #

# 2657AFGAC McKenzie Buffet

Assembly Instructions

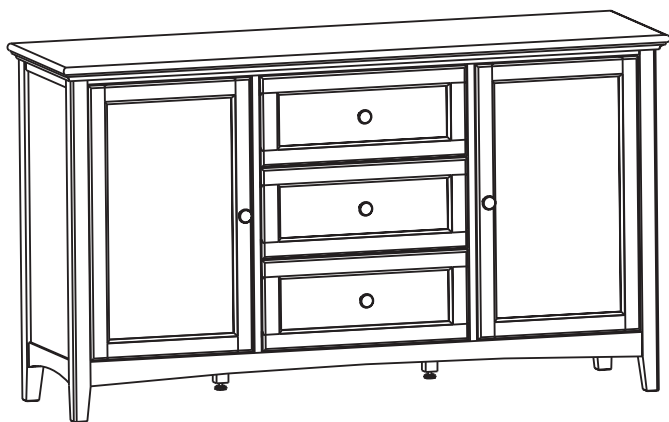

## Congratulations!

*This fine piece of furniture will make a handsome addition to your home. For the best results, start by reading the Assembly Instructions before you begin your project.*

**For normal household use only.  
NOT recommended for commercial use.**



**Unload items from this unit prior to moving.**

**Before loading or moving this unit, check all screws and supports for tightness.**

**Do not overload drawers or shelves in this unit.**

**Do not sit, stand or climb on this piece of furniture.**

**DESIGN SUBJECT TO CHANGE WITHOUT NOTICE.**

**Whittier  
Wood**  
FURNITURE

P.O. Box 2827  
Eugene, OR 97402 USA



**CALL US FIRST!**  
**DO NOT RETURN ITEM TO STORE**

**Service Policy:** We will replace parts which are defective, missing or damaged. Please contact Whittier Wood Products customer service department directly (by phone, fax, mail or E-mail) for replacement parts.

**Hours:** Our friendly customer service staff can be reached Monday-Friday 7:00 a.m. to 5:00 p.m. (Pacific Time). A message can be left 24 hours a day, 7 days a week.

**To Order:** Provide the complete furniture model number, part letter, production code, quantity needed, reason for replacement and your full name and address along with a telephone number in case we need to contact you.

*Parts ship from our Eugene, Oregon factory within 1 or 2 business days from the time we receive the request. Please allow 5-10 business days for delivery.*

**800-653-3336**

Outside U.S. or Canada: 541- 687- 0213

Fax: 541-687-2060 • [www.whittierwood.com](http://www.whittierwood.com)

Mail: P.O. Box 2827 • Eugene, Oregon 97402, U.S.A

## IMPORTANT NOTES:

- Read the Assembly Instructions completely before beginning your project.
- Store the item: 1) in the box; 2) in a dry place; 3) temperatures ranging from 40° to 90°. (Not on a cold, possibly damp, cement floor.)
- Inspect your furniture periodically for any loose glue joints or screws, or any other problem which may affect the stability of your furniture. Tighten or repair as needed.
- This Assembly requires two people.

Production Code:

VN

08/08

# 2657AFGAC McKenzie Buffet — Parts List

Please identify the parts and check that quantities received match those on this list.

If you need to replace a part, refer to the following letter and model name.



A — 2657 Top Assembly  
— Qty. 1 (Attached)

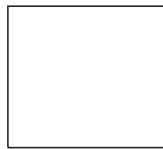

B — Adjustable Shelf — Qty. 4

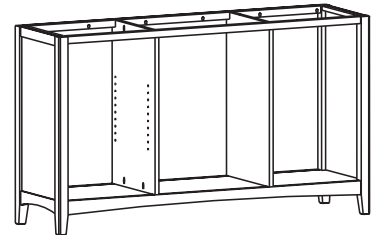

C — 2657 Case Only — Qty. 1

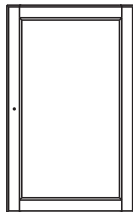

D — Door — Qty. 2 (Installed)

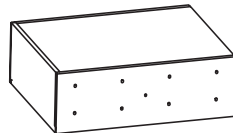

E — Drawer Box  
— Qty. 3 (Installed)



F — Drawer Face  
— Qty. 3 (Installed)



G — Drawer Slides  
— Qty. 3 sets (Installed)



H — Knob  
— Qty. 5 (Installed)



I — #8 x 1½" Machine Screw  
— Qty. 5 (Installed)



J — Shelf Bracket  
— Qty. 16 (Attached)



K — #6 x ½" Undercut Screw  
— Qty. 52 (Inserted)

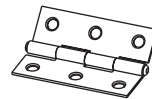

L — Hinge — Qty. 4  
(Installed)

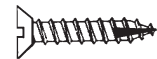

M — #6 x ¾" Brass Flat  
Head Screw — Qty. 24  
(inserted)

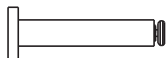

R — Assembled Foot  
— Qty. 2 (Attached)



S — T-Nut  
— Qty. 6 (Inserted)



T — Adjustable Glide  
— Qty. 2 (Installed)



U — Adjustable Glide  
— Qty. 4 (Installed)



N — Clip — Qty. 4



O — Nylon Restraint Strap  
— Qty. 2



P — #8 x 2" Black Screw  
— Qty. 4

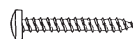

Q — #8 x 1" Pan Screw  
— Qty. 4

# 2657AFGAC McKenzie Buffet Assembly Instructions

TOOL REQUIRED: Phillips Screwdriver



1. Rotate the Adjustable Glides found at the bottoms of the Assembled Foot (R) until the unit is level.

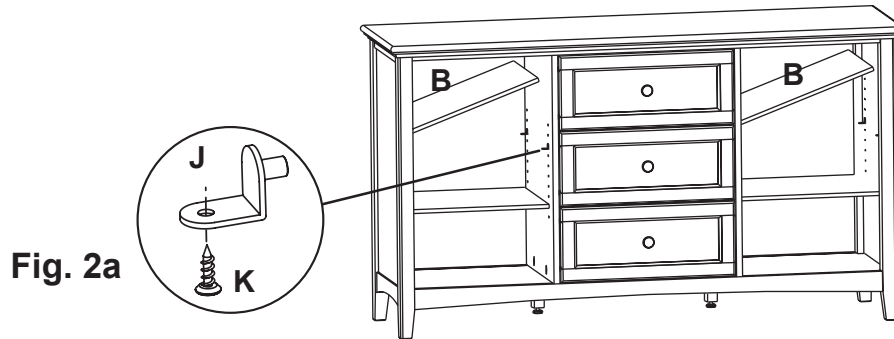

**Fig. 2**

*Doors removed for purposes of this illustration.*

2. Install the Adjustable Shelves (B) at the desired location using the Shelf Brackets (J). See Figure 2. Attach the shelves to the shelf brackets by inserting #6 x 1/2" Undercut Screws (K) through the bottom of the shelf bracket and into the shelf. See Figure 2a.

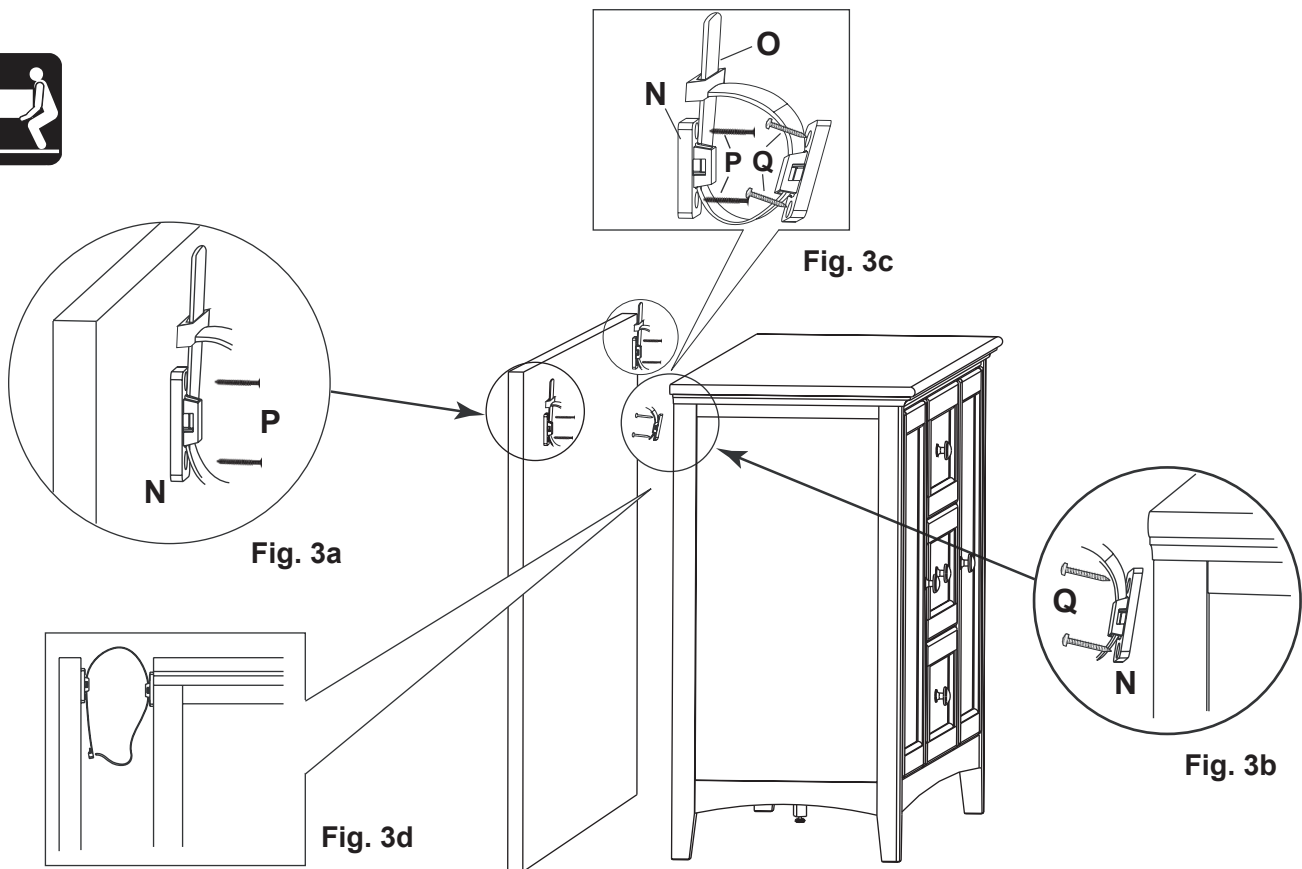

## Tipping Restraint

3. Position unit at desired location. Locate stud in the wall behind unit. Attach Clip (N) to wall stud with #8 x 2" Black Screws (P). See Figure 3a. Attach second clip to unit with #8 x 1" Pan Head Screws (Q). See Figure 3b. Connect the two clips with Nylon Restraint Strap (O). See Figures 3c and 3d. If studs cannot be located, purchase proper attachment hardware for your type of wall and secure unit according to that hardware's instructions.