

Model #

# 2091AUFa

## 64"W Pacific Sound Bar Console

Assembly Instructions

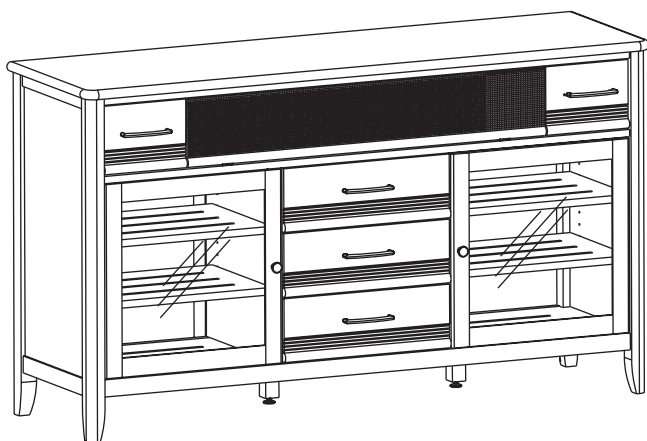

### Congratulations!

*This fine piece of furniture will make a gorgeous addition to your home. For the best results, read the Assembly Instructions and Finishing Hints before you begin your project.*

## ! WARNING

**Serious or fatal crushing injuries can occur from furniture tip-over. To help prevent tip-over:**

- Place heaviest items in the bottom drawers.
- Unless specifically designed to accommodate, do not set TVs or other heavy objects on top of this product.
- Never allow children to climb or hang on drawers, doors or shelves.
- Never open more than one drawer at a time.

**Properly installing tipping restraints reduces but does not eliminate the risk of tip-over.**



### IMPORTANT NOTES:

- For normal household use only. **Not** recommended for commercial use.
- Unload items before you move this unit.
- Before you load or move this unit, tighten all screws and supports.
- Do not climb, sit or stand on this piece of furniture.
- Do not overload drawers or shelves on this unit.
- Handle the glass plates with care. Glass is fragile.
- Before you begin your project, completely read the Assembly Instructions and Finishing Hints.
- Store this item: 1- in its box; 2- in a dry place; 3- in temperatures that range from 40°F to 90°F (not on a cold and possibly damp cement floor).
- Periodically inspect your furniture for any loose glue joints, screws or any other problem that might affect the stability of your furniture. Tighten or repair as needed.
- This assembly requires two people.

**DESIGN SUBJECT TO CHANGE WITHOUT NOTICE.**



**CALL US FIRST! Do not return this item to the store.**

**Service Policy:** We will replace any part that is defective, missing or damaged during assembly. For a replacement part, contact Whittier Wood Products customer service department by phone, fax, mail or email.

**Hours:** Our friendly customer service staff can be reached Monday-Friday 7:00 a.m. to 5:00 p.m. (Pacific Time). You may leave a message 24 hours a day, seven days a week.

**To Order:** Provide the furniture model number (upper left corner of this page), the part letter, production code, quantity needed, reason for replacement and your full name, address and telephone number.

*Parts ship from our Eugene, Oregon factory within one or two business days from the time we receive your request. Please allow five to ten business days for delivery.*

**800-653-3336** • Outside the U.S. or Canada: 541-687-0213 • Fax: 541-687-2060  
www.whittierwood.com • P.O. Box 2827 • Eugene, Oregon 97402, U.S.A.

**Whittier  
Wood**  
FURNITURE

P.O. Box 2827  
Eugene, OR 97402 USA

Production Code:











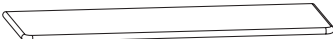

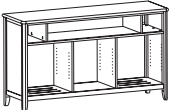











VN

10/11

# 2091AUFa 64"W Pacific Sound Bar Console — Parts List

Please identify the parts and check that quantities received match those on this list.



























If you need to replace a part, refer to the following letter and model number.

Part	Description	Quantity
A	Top (attached) 	1
B	Adjustable Shelf (attached) 	4
C	Case only 	1
D	Removable Back (installed) 	2
E	Door Frame (installed) 	2
F	Door Glass (installed) 	2
G	Speaker Door (attached) 	1
H	Small Drawer Box (installed) 	2
I	Small Drawer Face (installed) 	2
J	Large Drawer Box (installed) 	3
K	Large Drawer Face (installed) 	3
L	Glass Retainer (inserted) 	1
M	Shelf Bracket (attached) 	16
N	#6 x 1/2" Undercut Screw (inserted) 	16
P	Butler Hinge (attached) 	2
Q	Magnetic Push Lock (attached) 	2
R	#5 x 5/8" Flat Head Screw (inserted) 	12
S	Magnetic Plate (attached) 	2
T	#6 x 5/8" Undercut Screw (inserted) 	4
U	Drawer Slides (installed) 	5
V	#6 x 3/4" Philtruss Screw (inserted) 	30
W	#6 x 1/2" Philtruss Screw (inserted) 	34
X	Assembled Foot (attached) 	2
ZB	Small Adjustable Glide (installed) 	6

# 2091AUFa 64"W Pacific Sound Bar Console

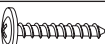
## — Parts List continued

Please identify the parts and check that quantities received match those on this list.  
If you need to replace a part, refer to the following letter and model number.

ZC	#8 x 2" Black Screw (inserted) 	4
ZD	Hinge (attached) 	4
ZE	Hinge Plate (attached) 	4
ZF	#6 x 3/4" P.O. Screw 	16
ZG	Knob (attached) 	2
ZH	#8 x 1-1/4" Machine Screw (installed) 	2
ZI	Handle (attached) 	5
ZK	Drawer Stop (attached) 	4
ZL	Turn Button (attached) 	8
ZM	#6 x 5/8" Philtruss Screw (inserted) 	30
ZN	#8 x 1-1/4" Pan Head Screw (inserted) 	34
ZO	#8 x 1-3/16" Pan Head Screw (inserted) 	6
ZP	#8 x 1-1/4" Black Screw (inserted) 	35
ZQ	#8 x 1" LoProfile Screw (inserted) 	20
ZR	Flat Washer (inserted) 	2
ZS	Hex Bumper (attached) 	2
ZT	Fitted Back (attached) 	1
ZU	Speaker Spacer 	2
ZV	Pad Strip (attached) 	4
ZW	Chain (attached) 	2
ZX	Cleat (attached) 	1
ZY	Push Plate 	2
ZZ	1/2" Dark Antique Brad 	4
YA	#8 x 1-1/8" LoProfile Screw (inserted) 	8
YB	3mm x 12mm Pan Head Screw (inserted) 	4
YC	Insert Nut (inserted) 	6
YD	#8 x 1-5/8" Machine Screw (installed) 	10
TR	Tipping Restraint	2 sets

# 2091AUFa 64"W Pacific Sound Bar Console Assembly Instructions

Tool Required: Phillips Screwdriver, Hammer

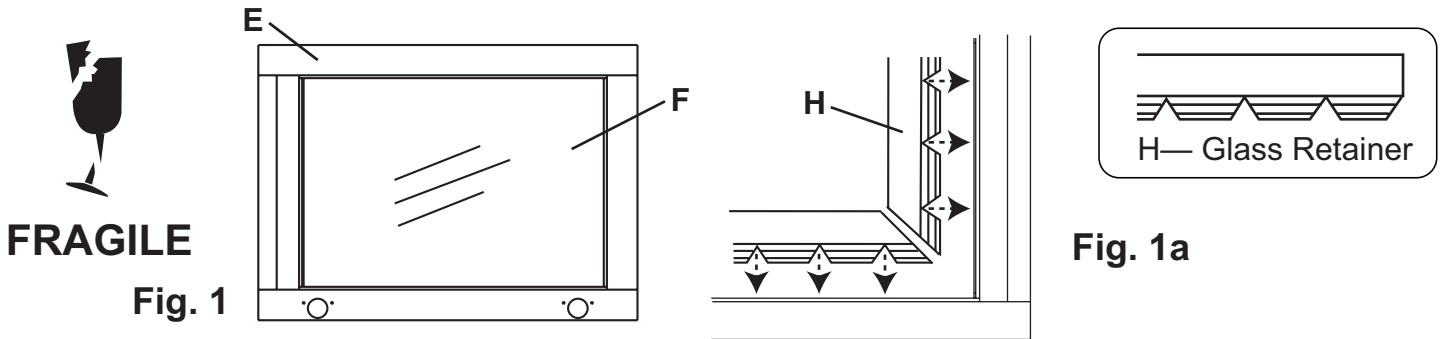

- CAUTION: DO NOT LEAN ON THE GLASS WHILE YOU WORK ON THE DOOR.**  
Remove the doors. Place the Door Frames (E) face-down on a clean, protected surface. Carefully remove the Glass Retainers (H) and the Door Glass (F).

**NOTE: APPLY FINISH TO THE DOOR NOW BEFORE YOU REINSTALL THE GLASS.**

Place the Door Frames (E) face-down on a clean, protected surface. Carefully center the Door Glass (F) in the Door Frame. Place the glass retainer pieces flat on the glass and gently press the notched edges into the door frame. See Figures 1 and 1a. Repeat. Attach the doors.

**Optional:** Attach the Push Plates (ZY) when the console will be placed in a high-use area such as a retail sales floor where the Sound Bar Speaker Door will be opened and closed often.

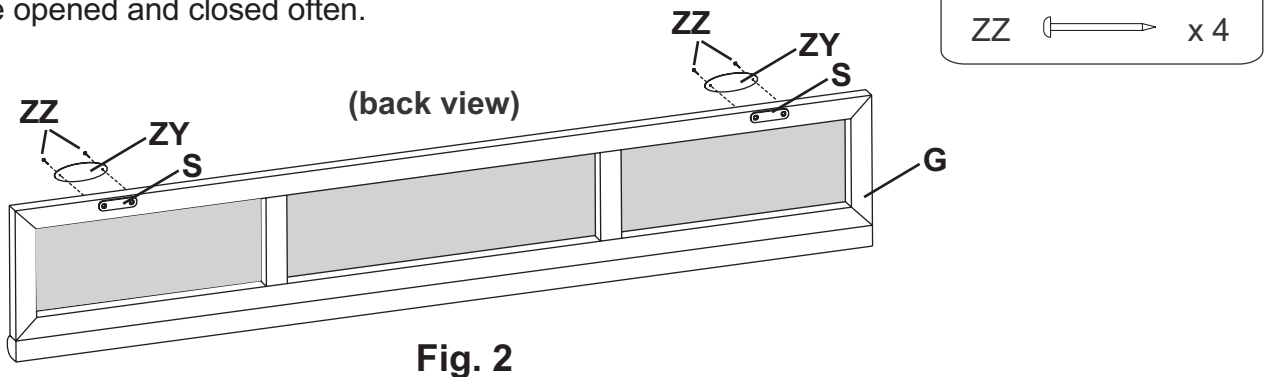

- Remove the Speaker Door (G) and apply the finish. After the finish has dried, place the Door face-up on a clean protected surface. Center a Push Plate (ZY) over the right Magnetic Plate (S) and attach with two 1/2" Dark Antique Brads (ZZ). Repeat for the left side. See Figure 2. Attach the Door.

IF you choose not to attach the Push Plates, remove the Door, apply finish and then rehang the door.



- Place the console at its final destination. Rotate the Small Adjustable Glides (ZB) on the bottoms of the legs until the unit is level.

**Fig. 4**

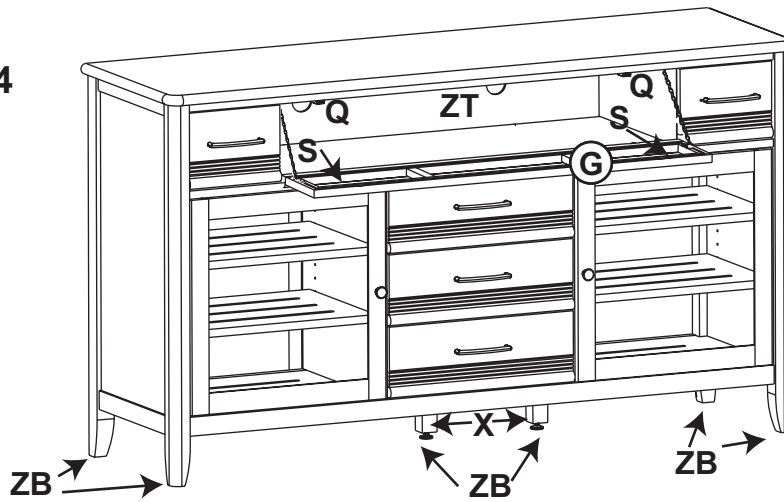

4. To open the Speaker Door (G), simultaneously press the Push Plates or both corners until the magnets release. Gently grasp the middle of the door and pull it open. To shut the door, push gently but firmly on the Speaker Door (G) until the two Magnetic Plates (S) make secure contact with the Magnetic Push Locks (Q).

If you did not install the Push Plates, gently press on both corners until the magnets release. See Figure 4.

If you need to install your sound bar from the back, remove the #6 x 1/2" Philtruss Screws (W) and pull away the fitted back (ZT). After installing the component, replace the Fitted Back and attach with the #6 x 1/2" Philtruss Screws.

**Fig. 5**

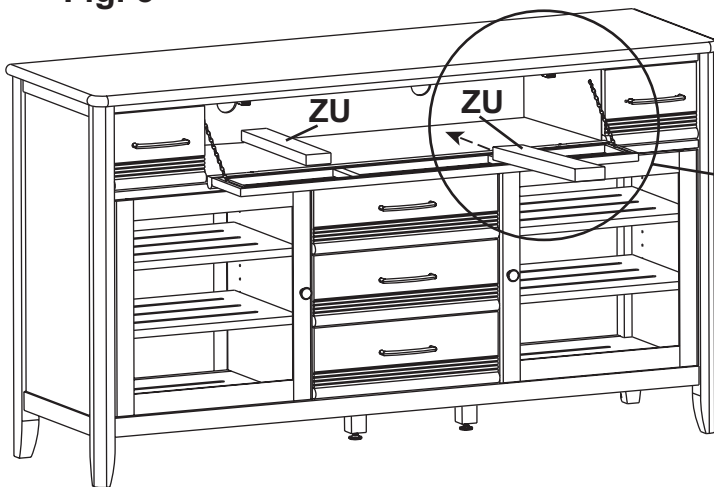

**Fig. 5a**

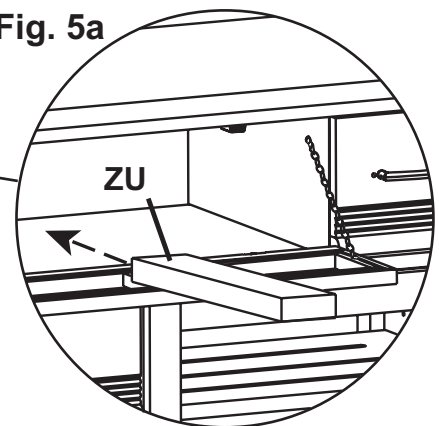

5. If your center sound bar needs to sit above the edge of the speaker door, place the two Speaker Spacers (ZK) into the sound compartment so the Pad Strips (ZL) face down. Place the speaker on top of the Spacers. See Figures 5 and 5a.

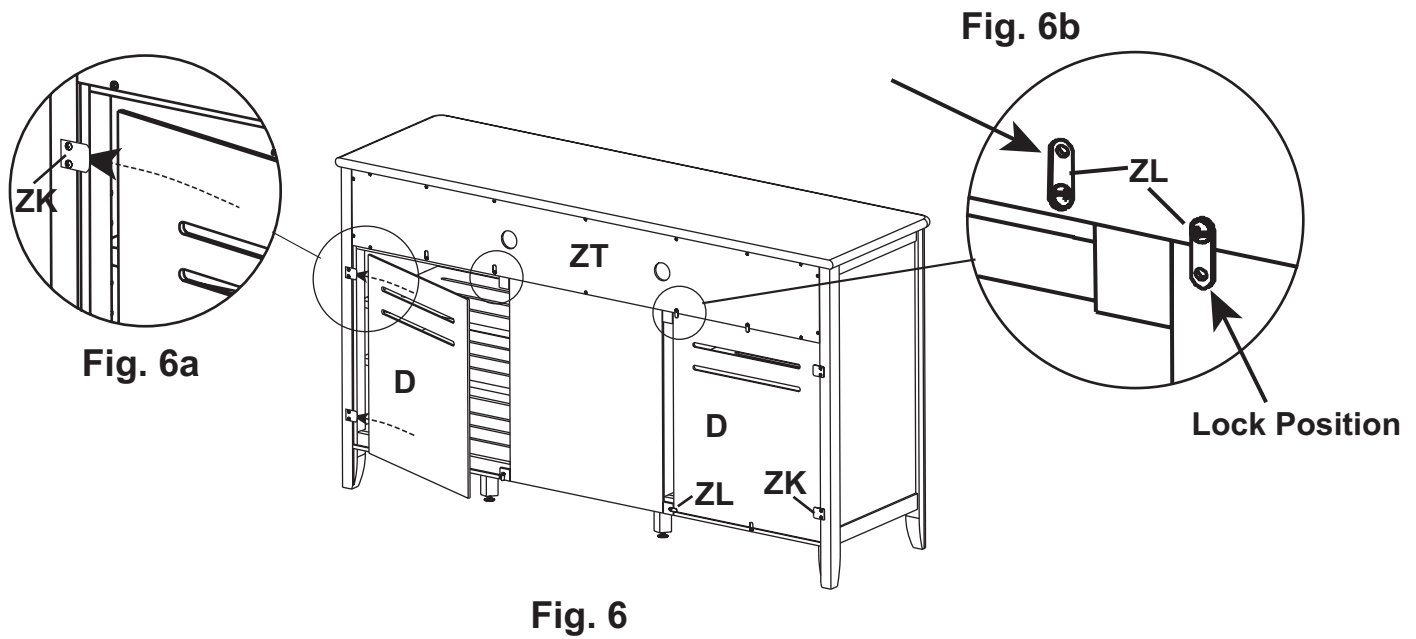

- To insert your media components and access wires into the console more easily, you may want to remove the Removable Backs (D). To do so, unlock the Turn Buttons (ZL) as shown in Figures 6 and 6b. Slide the Backs away and place them off to the side. To put them back into place, slide the Backs behind the Drawer Stops (ZK) and position the Turn Buttons so that they are locked. See Figures 6a and 6b.

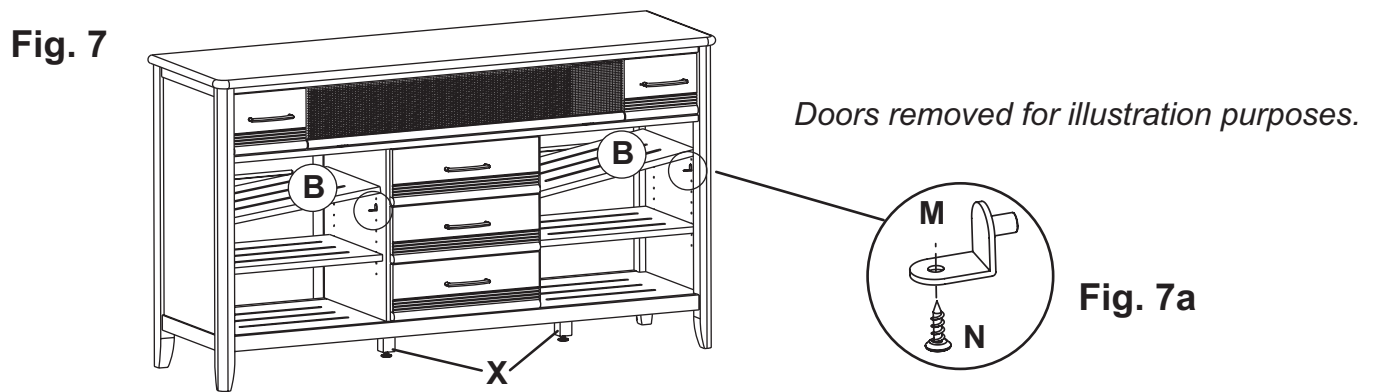

- Determine where you want to place the Adjustable Shelves (B). To support each shelf, tap the Shelf Brackets (M) into the four holes with the flat side down. Insert the shelf as shown in Figure 7. You may fasten the brackets to the shelf by inserting a #6 x 1/2" Undercut Screw (C). Repeat for each shelf. See Figure 7a.

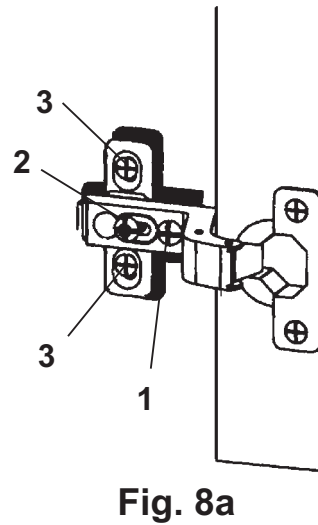
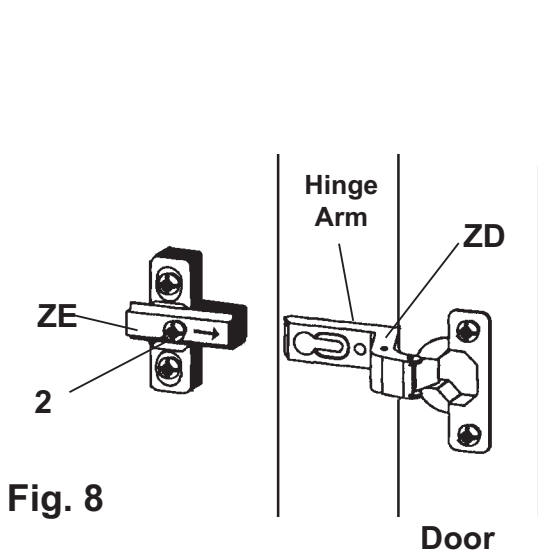

**Side adjustment 4mm (5/32")**  
To move the door towards the side panel, loosen screw '1' and tighten screw '2'. To move the door away from the side panel, loosen screw '2' and tighten screw '1'.

**Depth Adjustment 4mm (5/32")**  
Loosen screw '2' (just one turn), adjust the door to the desired position and re-tighten the screw.

**Height Adjustment 4mm (5/32")**  
Loosen screw '3', adjust the door to the desired position and re-tighten the screw.

8. If you need to adjust the doors, follow the above instructions.

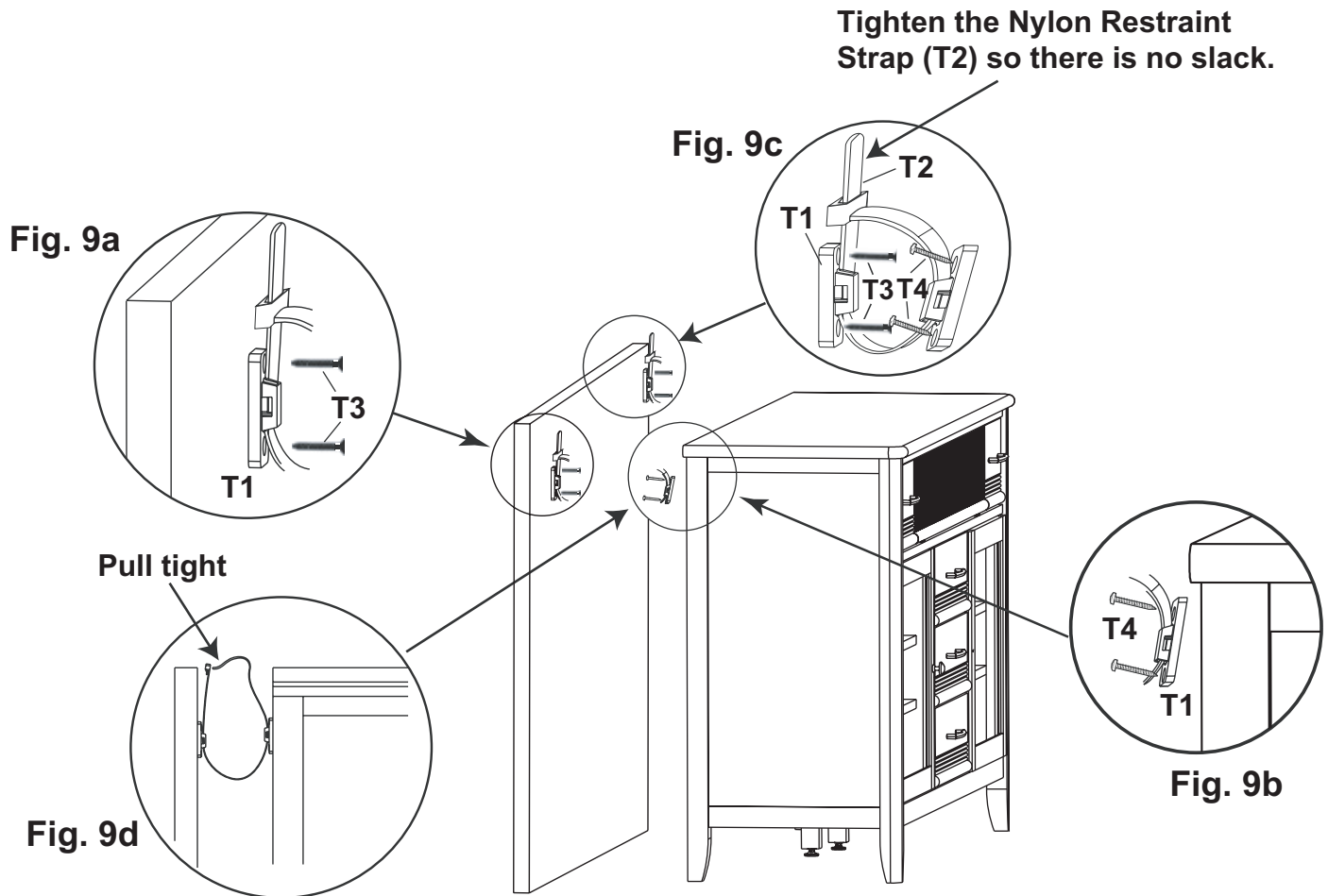

### Tipping restraint:

- Position the unit at the desired location. Locate two studs in the wall behind the unit. Attach a Clip (T1) to one wall stud with two #8 x 2" Black Screws (T3). See Figure 9a. Attach a second clip to the unit with two #8 x 1" Pan head Screws (T4). See Figure 9b. Connect the two clips with the Nylon Restraint Strap (T2). Pull the Nylon Restraint Strap (T2) tight so there is no slack. See Figures 9c and 9d. Repeat this procedure to attach the second tipping restraint. If you cannot locate two studs, purchase the proper wall attachment hardware for your type of wall and secure the unit.

# Whittier Finishing Hints

## Checklist of materials

- |   |  |  |
|---|--|--|
| <input type="checkbox"/> Rubber gloves  | <input type="checkbox"/> Tack cloth                            | <input type="checkbox"/> #220 & #320 sandpaper |
| <input type="checkbox"/> Lint-free rags | <input type="checkbox"/> Drop cloth                            | <input type="checkbox"/> Painter's tape        |
| <input type="checkbox"/> Paper towels   | <input type="checkbox"/> Stain brushes (poly bristle and foam) | <input type="checkbox"/> Wood glue             |
| <input type="checkbox"/> Cotton swabs   |  |  |

## Getting started

Assembly Instructions may contain special finishing information or gluing requirements for that item.

Completely read both the Assembly Instructions and these Finishing Hints before you begin your project.

**Choosing the finish:** Ask your retailer for advice on how to finish bare wood. Choose a finish that meets your expectations for the end use of the product. Will you use it as a work surface as on a desk or kitchen island? Are you matching a finish on existing furniture? The answers to these questions may affect the type of finish you choose.

**Where to work:** Choose an area that has good light and is well ventilated, warm and dry. If the work area is cold and damp, the wood finishing products may require a longer drying time than the labels indicate. Do not work in a dirty or dusty area – dirt and/or dust can embed in the finish.

## Gluing hints

These are general hints. Refer to the Assembly Instructions for detailed information on how to glue your specific product. Use wood glue such as Elmer's Wood Glue, Titebond Wood Glue or the equivalent. Some instructions call for a slow drying epoxy glue. Carefully read the label and instructions of the glue manufacturer. Your unit may not need glue.

1. We strongly recommend that you lay out all the parts and familiarize yourself with how they fit together before assembling with glue. Glue will set up quickly. You can damage parts if you try to reposition any that have been assembled incorrectly.

2. For glue to properly bond, it is very important to apply the wood glue to bare wood. Protect your eyes and blow into holes to clear excess dust. This will help the glue to adhere to a clean surface.
3. If you plan on finishing the product before you assemble it, place painter's tape three-fourths of the way up from the end of a dowel, spindle or tenon. This protects the ends from the finishing product but allows finish application where it will be visible. Finishing products inhibit the bonding properties of wood glue. Remove the tape prior to the final assembly.
4. Avoid getting glue on surfaces to be finished. Most stains or finishes will not penetrate where glue has been spilled. Wet glue can be wiped off with a damp cloth. Follow with a light sanding of the area to ensure a proper finish.
5. It is important to apply an even coat inside holes and slots. Use a small dowel, pencil or cotton swab to spread glue evenly around the inside of the holes. Do not over glue. The tight fit of the spindles or dowels in the holes can cause glue to be pushed to the bottom of the hole. If too much glue is used it will fill the holes and not allow the spindle or dowel to be fully inserted.
6. Glue usually takes several hours to cure or harden but it will set up or grab in several seconds. Once you begin final assembly, proceed quickly.

## Finishing hints

1. Use products of the same brand to ensure compatibility. It is not recommended to mix solvent based and water based finishes. *Always read and follow all label directions on the can.*
2. Alder is a porous hardwood and often looks best when following the finishing instructions for softwoods.
3. Use a wood conditioner under oil base stains.

## Preparing the surface

1. Sand each piece with #220 grit sandpaper. Sand with the grain of the wood on flat surfaces and opposite the grain on turnings. Some parts may be plywood. Be careful not to sand through the veneer. End grain such as table top ends, seat edges and grooves on turnings accept more stain. Extra sanding in these areas with #320 grit sandpaper reduces stain absorption and creates a more evenly stained piece.
2. When sanding is completed, wipe the surface of your furniture with a lint-free rag or tack cloth. Make sure the item is free of dust before you proceed.

## Staining

1. Read and follow label directions. Stir the stain well before you start. Stir periodically throughout the duration of the project to maintain uniform color consistency.
2. Test stain on an inconspicuous spot on your project. Put at least one coat of your top coat over the test area as it also affects the look of the stain. *Test every type of wood that is in your kit. These are identified in the Assembly Instructions.* Different types of wood may react differently to the stain color. You might need to add a second coat of stain to lighter woods to match the darker woods in your kit.
3. Apply stain with a poly brush or lint-free cloth. Apply stain over a small area and wipe off excess. Working in small areas will make the color easier to control.
4. Cotton swabs are ideal for hard to reach areas.
5. Allow the stain to dry thoroughly before you proceed.

## Applying the top coat

1. *Always read and follow all label directions.* Stir your top coat gently; do not shake. Shaking the can creates bubbles that are hard to remove.
2. All surfaces including the underside of table tops and inside drawers must be sealed with at least one layer of a top coat. This will help minimize wood swelling, shrinkage, warping and cupping due to changes in moisture content or temperature.

3. Apply a minimum of two coats when you use polyurethane or varnish (especially on all table top and work surfaces). After allowing the first coat to dry, sand lightly with #320 grit sandpaper. Remove dust with a lint-free rag or tack cloth. For added protection, apply additional coats. Lightly sand and wipe surface with a lint-free rag or tack cloth between coats.
4. Some finishes tend to slightly raise the grain. This can be easily controlled with a light sanding between coats. Do not use steel wool when you use water-based finishes. Strands of steel fiber caught in the wood can cause rust spots when coated with any water-based product.

## Painting

1. Since there is a large variation between paint manufacturers and products, ask your paint supplier for specific advice on how to best use the paint you purchase. Ask them specifically for advice on finishing bare wood.
2. First coat the wood with a primer. An oil based primer works best for a smooth finish. If you do not wish to use a solvent based primer, water based primer works almost as well. However it may raise the wood grain and require additional sanding.
3. Buy quality brand paint in a satin, semi-gloss, or gloss sheen. Apply a second coat for a smooth finish. Lightly sand between coats using with #320 grit sandpaper so that the second coat will bond well. Be sure to use a tack cloth after sanding to remove any residue. Repeat as desired.
4. No top coat is required when using paint.