

McKenzie Media Consoles

Model No.

54"W 2068AFGACb;

64"W 2069AFGACb

54"W 2068AFCAFb;

64"W 2069AFCAFb

AFGAC = Glazed Antique Cherry finish

AFCAF = Caffè finish

Assembly Instructions

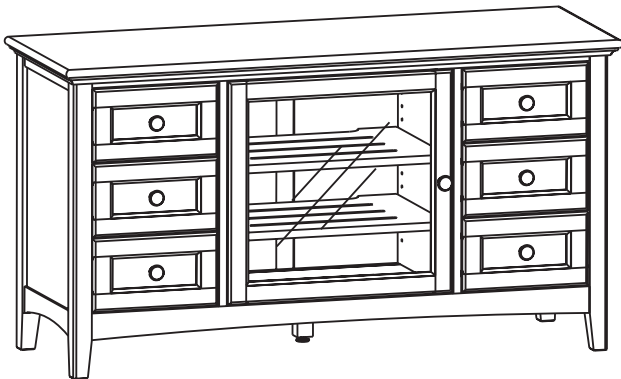

Congratulations!

This fine piece of furniture will make a gorgeous addition to your home. For the best results, read the Assembly Instructions before you begin your project.

! WARNING

Serious or fatal crushing injuries can occur from furniture tip-over. To help prevent tip-over:

- Place heaviest items in the bottom drawers.
- Unless specifically designed to accommodate, do not set TVs or other heavy objects on top of this product.
- Never allow children to climb or hang on drawers, doors or shelves.
- Never open more than one drawer at a time.

Use of tip-over restraints may only reduce but not eliminate the risk of tip-over.



IMPORTANT NOTES:

- For normal household use only. **Not** recommended for commercial use.
- Unload items before you move this unit.
- Before you load or move this unit, check to make sure all screws and supports are tight.
- Handle the glass plates with care. Glass is fragile.
- Before you begin your project, completely read the Assembly Instructions.
- Store this item: 1- in its box; 2- in a dry place; 3- in temperatures that range from 40°F to 90°F (not on a cold and possibly damp cement floor).
- Periodically inspect your furniture for any loose glue joints, screws or any other problem that might affect the stability of your furniture. Tighten or repair as needed.

DESIGN SUBJECT TO CHANGE WITHOUT NOTICE.



CALL US FIRST! *Do not return this item to the store.*

Service Policy: We will replace any part that is defective, missing or damaged during assembly. For a replacement part, directly contact Whittier Wood Products customer service department by phone, fax, mail or email.

Hours: Our friendly customer service staff can be reached Monday-Friday 7:00 a.m. to 5:00 p.m. (Pacific Time). You may leave a message 24 hours a day, seven days a week.

To Order: Provide the finish, furniture model number (upper left corner of this page), the part letter, production code, quantity, reason for replacement and your full name, address and telephone number.

Parts ship from our Eugene, Oregon factory within one or two business days from the time we receive your request. Please allow five to ten business days for delivery.

800-653-3336 • Outside the U.S. or Canada: 541-687-0213 • Fax: 541-687-2060
www.whittierwood.com • P.O. Box 2827 • Eugene, Oregon 97402, U.S.A.

**Whittier
Wood**
FURNITURE

P.O. Box 2827
Eugene, OR 97402 USA

Production Code:











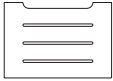



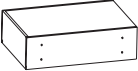

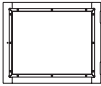
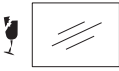
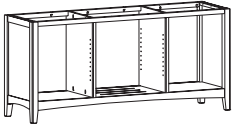
VN

10/11

2068AFGACb; 2068AFCAFb 54"W Media Console & 2069AFGACb; 2069AFCAFb 64"W Media Console — Parts List

Please identify the parts and check that quantities received match what is on this list.











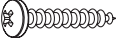
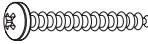
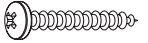

If you need to replace a part, refer to the following letter and item name.

Part	Description	Quantity	
		2068AFGACb 2068AFCAFb	2069AFGACb 2069AFCAFb
A	Top Assembly 	1	1
Bb	Adjustable Shelf 	2	2
C	Knob (attached) 	7	7
D	#8x1-1/2" Machine Screw (inserted) 	7	7
E	Drawer Face (installed) 	6	6
F	Drawer Box (inserted) 	6	6
G	Drawer Slides (pre-installed sets) 	6	6
Ha	Door Frame 	1	1
la	Door Glass (attached) 	1	1
Jb	Case 	1	1
L	Shelf Brackets (installed) 	8	8
M	#6 x 1/2" Undercut Screw (inserted) 	8	8
Nb	Removable Back (attached) 	2	2
O	Door Glass Support Rail (attached) 	2	2
P	Door Glass Support Stile (attached) 	2	2
Q	#6 x 3/4" Brass Flat Head Screw (inserted) 	12	12
R	Magnetic Catch Kit (installed) 	2	2
S	#6x5/8" Philtruss Screw (inserted) 	16	16
U	Hinge (attached) 	2	2

2068AFGACb; 2068AFCAFb 54"W Media Console & 2069AFGACb; 2069AFCAFb 64"W Media Console — Parts List continued

Please identify the parts and check that quantities received match what is on this list.

If you need to replace a part, refer to the following letter and item name.

Part	Description	Quantity	
		2068AFGACb 2068AFCAFb	2069AFGACb 2069AFCAFb
X	Small Adjustable Glide (installed) 	5	5
Y	#8 x 7/8" Lo-Profile Screw (inserted) 	24	24
Z	#6 x 5/8" Flat Head Screw (inserted) 	12 (AFGAC) 0 (AFCAF)	12 (AFGAC) 0 (AFCAF)
ZA	#8 x 1" Pan Head Screw (inserted) 	4	4
ZB	#8 x 1-1/4" Pan Head Screw (inserted) 	14	16
ZC	#8 x 1-3/16" Pan Head Screw (inserted) 	6	6
ZD	#8 x 1-1/4" Black Screw (inserted) 	11	12
ZE	#8 x 2" Black Screw (inserted) 	2	2
ZG	Drawer Stop (attached) 	4	4
ZH	Turn Button (attached) 	4	4
ZI	#6 x 5/8" Undercut Screw (inserted) 	4 (AFGAC) 16 (AFCAF)	4 (AFGAC) 16 (AFCAF)
ZJ	#6 x 1/2" Philtruss Screw (inserted) 	36	36
ZK	#6 x 3/4" Philtruss Screw (inserted) 	36	36
ZQ	Foot Assembly (attached) 	1	1
ZR	#8 x 1-1/8" Lo-Profile Screw (inserted) 	4	4
ZS	Insert Nut (inserted) 	5	5
TR	Furniture Tipping Restraint	2	2

2068AFGACb; 2068AFCAFb 54"W Media Console 2069AFGACb; 2069AFCAFb 64"W Media Console Assembly Instructions

Tool Required: Phillips Screwdriver



1. Place the console at its final destination. Rotate the Small Adjustable Glides found at the front corners of the unit and at the bottoms of the Assembled Foot (ZQ) until the unit is level.

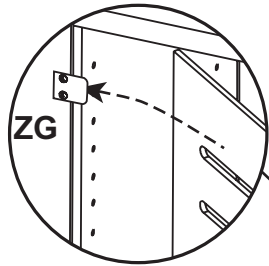

Fig. 2a

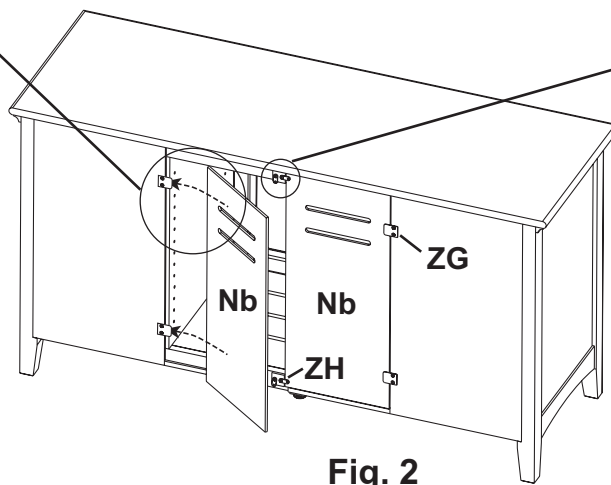
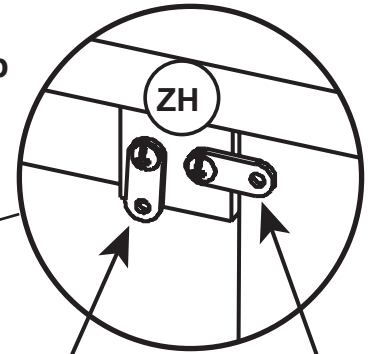

Fig. 2

Fig. 2b



Unlocked
Position

Locked
Position

2. You may want to remove the Removable Backs (Nb) so that you can place your media units into the console more easily. To do so, unlock the Turn Button (ZH) as shown in Figures 2 and 2b. Slide the backs away and place them off to the side. To put them back into place, slide the backs behind the Drawer Stops (ZG) and position the Turn Button so that it is locked. See Figures 2a and 2b.

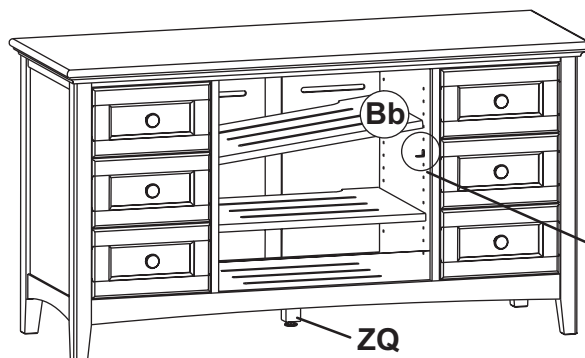

Fig. 3a

Door removed for illustration purposes.

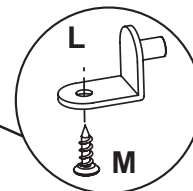
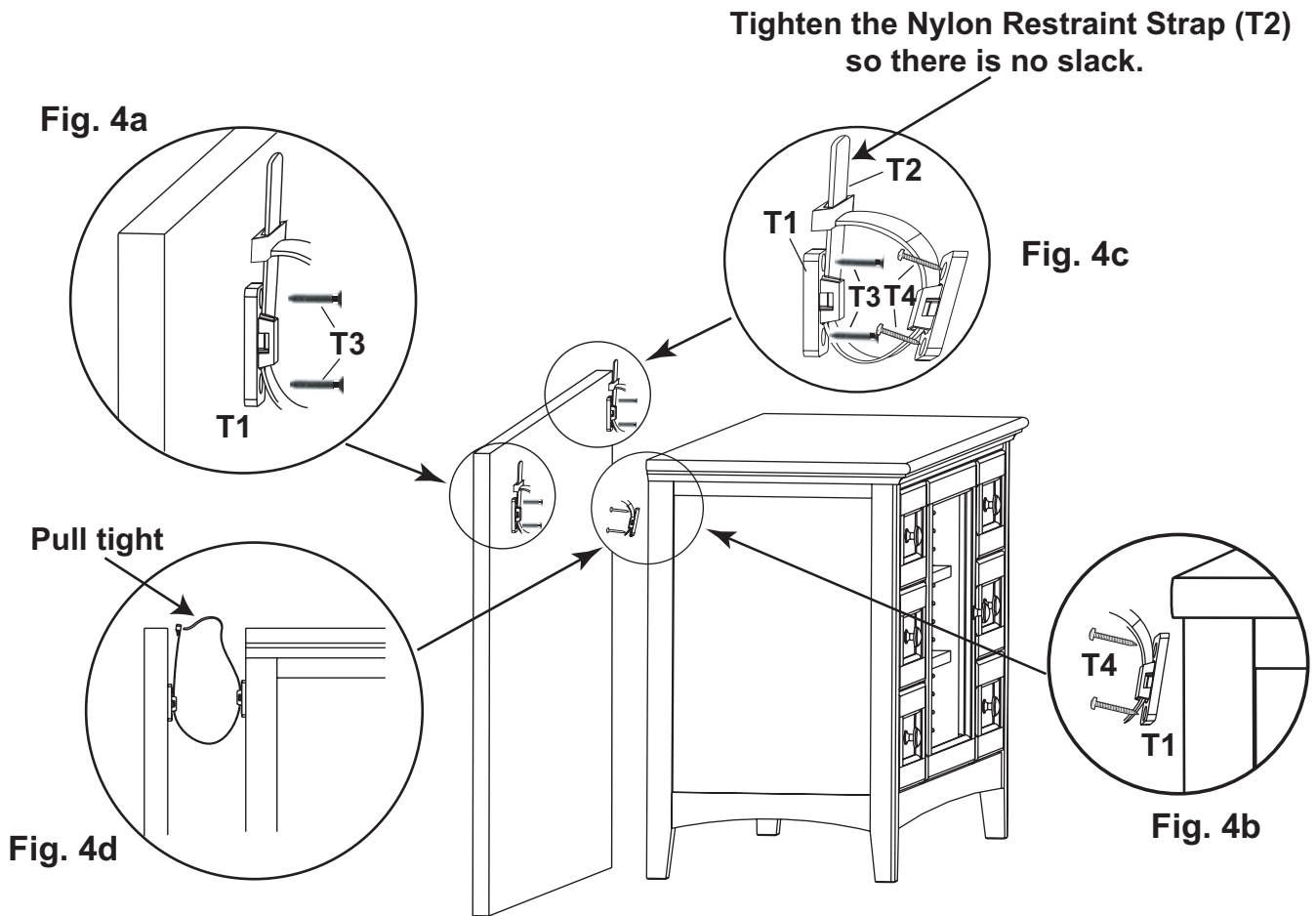

Fig. 3b

3. To move the Adjustable Shelves (Bb), remove the #6 x 1/2" Undercut Screws (M) and the Shelves (Bb). Reposition the Shelf Brackets (L) to the desired positions, replace the shelf and insert the screws. See Figures 3a and 3b.



Tipping restraint:

4. Locate two studs in the wall behind the unit. Attach a Clip (T1) to one wall stud with two #8 x 2" Black Screws (T3). See Figure 4a. Attach a second clip to the unit with two #8 x 1" Pan Head Screws (T4). See Figure 4b. Connect the two clips with the Nylon Restraint Strap (T2). **Pull the Nylon Restraint Strap (T2) tight so there is no slack.** See Figures 4c and 4d. Repeat this procedure to attach the second tipping restraint. If you cannot locate two studs, purchase the proper wall attachment hardware for your type of wall and secure the unit.