

# Cascade Bed Collection

Glazed Black Cherry finish

Assembly Instructions

Model #

**1877GBCH**

Cascade Queen Bed

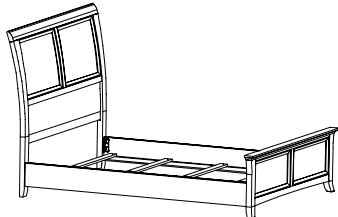

Model #

**1882GBCH**

Cascade King Bed

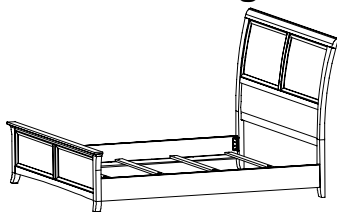

Model #

**1886GBCH**

Cascade Cal-King Bed

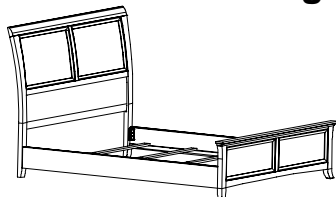

## IMPORTANT NOTES:

- For normal household use only. *Not* recommended to use these units in a commercial setting.
- Remove items before you move this unit.
- Before you load or move this unit, tighten all screws and supports.
- Before you begin your project, completely read the Assembly Instructions.
- Store this item: 1- in its box; 2- in a dry place; 3- in temperatures that range from 40°F to 90°F (not on a cold and possibly damp cement floor).
- Periodically inspect your furniture for any loose glue joints, screws or any other problem that might affect the stability of your furniture. Tighten or repair as needed.

**DESIGN SUBJECT TO CHANGE WITHOUT NOTICE**

## Congratulations!

*This fine piece of furniture will make a gorgeous addition to your home. For the best results, read the Assembly Instructions before you begin your project.*



**CALL US FIRST!** *Do not return this item to the store.*

**Service Policy:** We will replace any part that is defective, missing or damaged during assembly. For a replacement part, contact Whittier Wood Products customer service department by phone, fax, mail or email.

**Hours:** Our friendly customer service staff can be reached Monday-Friday 7:00 a.m. to 5:00 p.m. (Pacific Time). You may leave a message 24 hours a day, seven days a week.

**To Order:** Provide the finish and furniture model number (above the illustration of your unit), the part letter, production code, quantity needed, reason for replacement and your full name, address and telephone number.

*Parts ship from our Eugene, Oregon factory within one or two business days from the time we receive your request. Please allow five to ten business days for delivery.*

800-653-3336 • Outside the U.S. or Canada: 541-687-0213 • Fax: 541-687-2060  
www.whittierwood.com • P.O. Box 2827 • Eugene, Oregon 97402, U.S.A.

**Whittier  
Wood**  
FURNITURE

P.O. Box 2827  
Eugene, OR 97402 USA

Production Code:

VN











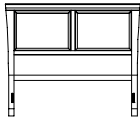
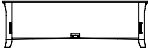
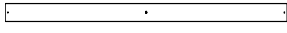
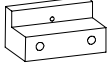

08/11

**1877GBCH Cascade Queen Bed; 1882GBCH Cascade King Bed;  
1886GBCH Cascade Cal-King Bed**

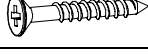
*Parts List*

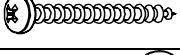
Please identify the parts and check that quantities received match those on this list.  
If you need to replace a part, refer to the following letter and part name.

**1879GBCH Queen Bed (Headboard/Footboard Kit)  
1884GBCH King Bed (Headboard/Footboard Kit)  
1888GBCH Cal-King Bed (Headboard/Footboard Kit)**



Part	Description	Quantity		
		1879 GBCH	1884 GBCH	1888 GBCH
A	Headboard 	1	1	1
B	Footboard 	1	1	1
C	Slat 	5	5	5
D	Slat Support (attached) 	1	1	1
E	Assembled Foot 	4	4	4
F	T-Nut (inserted) 	9	9	9
G	Hanger Bolt (inserted) 	4	4	4
H	Adjustable Glide 	4	4	4
I	Male Bracket (attached) 	4	4	4
J	#8 x 1" Black Screw (inserted) 	16	16	16
K	#8 x 1-1/4" Black Screw 	10	10	10
L	#8 x 1-3/4" Pan Head Screw (inserted) 	5	5	5
M	1/4" Lock Washer 	8	8	8
N	1/4" x 1/2" Hex Bolt 	8	8	8
O	5mm Hex Wrench 	1	1	1

*1879 shown in illustrations.*

**1877GBCH Cascade Queen Bed; 1882GBCH Cascade King Bed;  
1886GBCH Cascade Cal-King Bed**  
*Parts List*

---

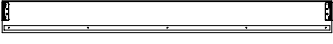
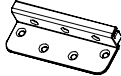
**1880GBCH Queen/King Bed Rail Kit;  
1889GBCH Cal-King Bed Rail Kit**

Part	Description	Quantity	
		1880 GBCH	1889 GBCH
J	#8 x 1" Black Screw (inserted) 	16	16
P	Side Rail 	2	2
Q	Female Bracket (attached) 	4	4
R	#8 x 2" Black Screw (inserted) 	22	22

*1880 shown in illustrations.*

# 1877GBCH Cascade Queen Bed; 1882GBCH Cascade King Bed; 1886GBCH Cascade Cal-King Bed

## Assembly Instructions

This assembly requires two people.

**Tools Required: 5mm Hex Wrench (provided) and Phillips Screwdriver**

1. Remove the Slats (C) from the back of the Headboard (A) as seen in Figure 1 and place them off to the side.

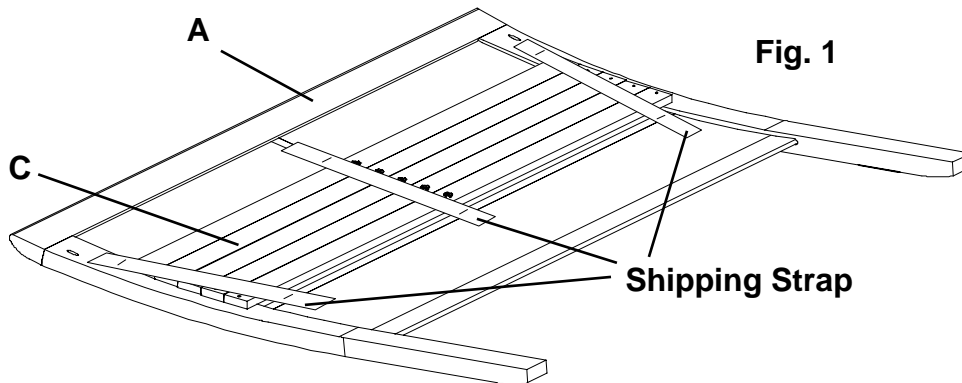

2. Using the Hex Wrench (O) provided, attach the Rails (P) to the Headboard (A) with four 1/4" x 1/2" Hex Bolts (N) and 1/4" Lock Washers (M) as shown in Figures 2 and 2a.

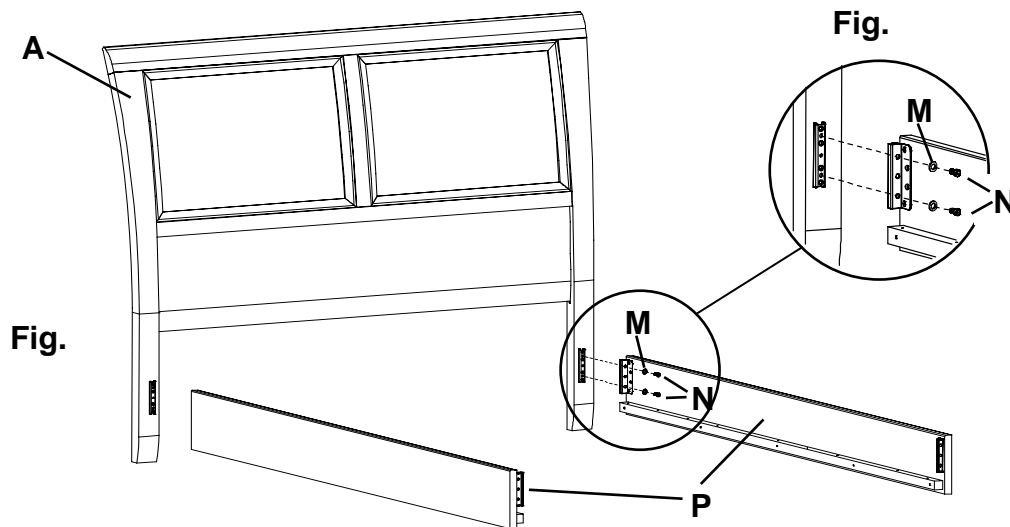
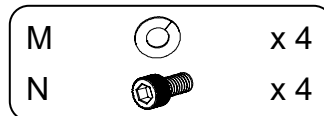



# 1877GBCH Cascade Queen Bed; 1882GBCH Cascade King Bed; 1886GBCH Cascade Cal-King Bed

## Assembly Instructions

This assembly requires two people.

- Using the Hex Wrench (O) provided, attach the Footboard (B) to the Rails with four 1/4" x 1/2" Hex Bolts (N) and 1/4" Lock Washers (M) as shown in Figures 3 and 3a.



M		x 4
N		x 4

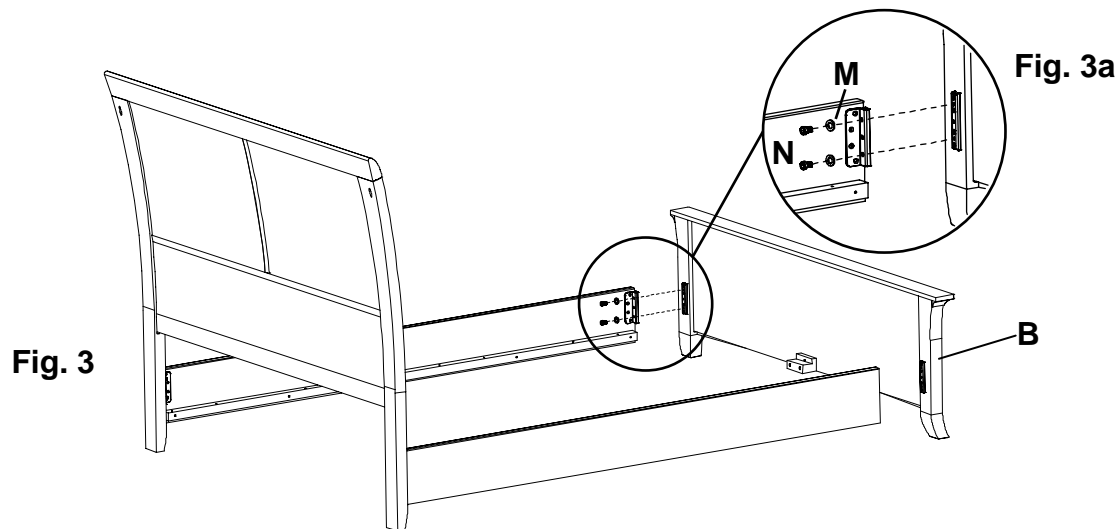

- Attach an Assembled Foot (E) to each of the four of the Slats (C) as shown in Figure 4.

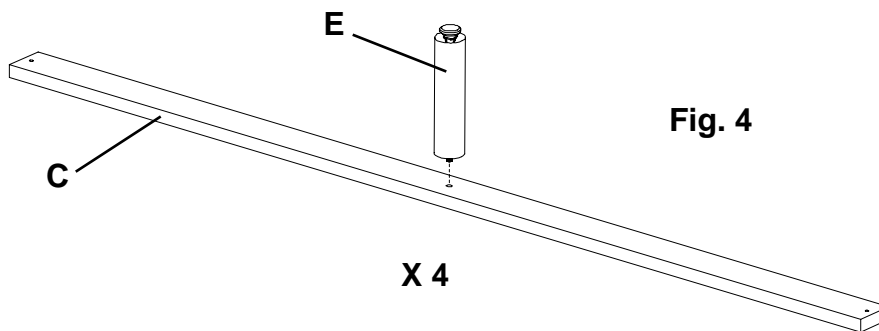

# 1877GBCH Cascade Queen Bed; 1882GBCH Cascade King Bed; 1886GBCH Cascade Cal-King Bed

## Assembly Instructions

This assembly requires two people.



5. Place the bed at its final location.
6. Position the Slats (C) on the bottom edges of the rails and place the slat without the Foot Assembly nearest to the Footboard. Attach with #8 x 1-1/4" Black Screws (K). See Figure 6.

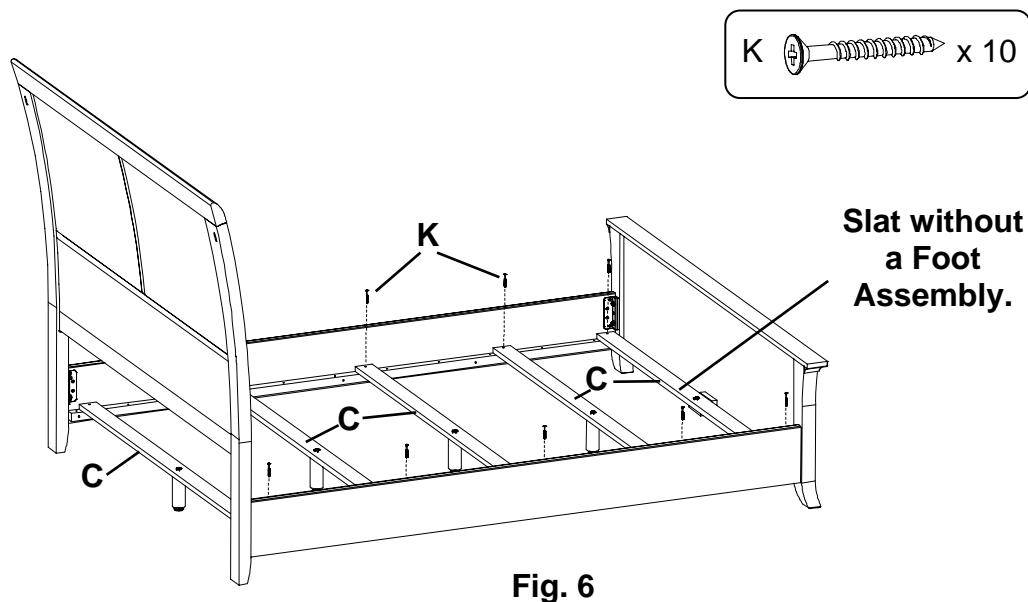

7. Adjust the Glides (H) on the Foot Assemblies (E) so the Glides just touch the floor, making sure the Foot Assemblies bear weight.

