

Model #

1367AUF McKenzie Full Bookcase Headboard

Assembly Instructions

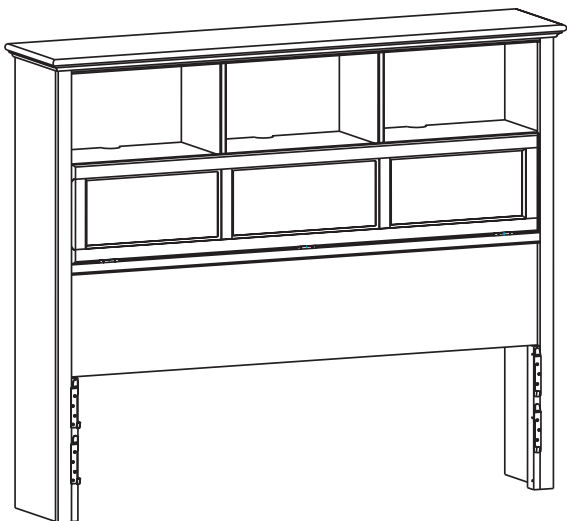

Congratulations!

This fine piece of furniture will make a gorgeous addition to your home. For the best results, read the Assembly Instructions and Finishing Hints before you begin your project.

IMPORTANT NOTES:

- For normal household use only. **Not** recommended for commercial use.
- Unload items before you move this unit.
- Before you load or move this unit, tighten all screws and supports.
- Do not overload the concealed storage areas.
- Do not overload the cubbies.
- Before you begin your project, completely read the Assembly Instructions and Finishing Hints.
- Store this item: 1- in its box; 2- in a dry place; 3- in temperatures that range from 40°F to 90°F (not on a cold and possibly damp cement floor).
- Periodically inspect your furniture for any loose glue joints, screws or any other problem that might affect the stability of your furniture. Tighten or repair as needed.
- This assembly requires two people.

DESIGN SUBJECT TO CHANGE WITHOUT NOTICE.



CALL US FIRST! *Do not return this item to the store.*

Service Policy: We will replace any part that is defective, missing or damaged during assembly. For a replacement part, contact Whittier Wood Products customer service department directly by phone, fax, mail or email.

Hours: Our friendly customer service staff can be reached Monday-Friday 7:00 a.m. to 5:00 p.m. (Pacific Time). You may leave a message 24 hours a day, seven days a week.

To Order: Provide the furniture model number (upper portion of this page), the part letter, production code, quantity needed, reason for replacement and your full name, address and telephone number.

Parts ship from our Eugene, Oregon factory within one or two business days from the time we receive your request. Please allow five to ten business days for delivery.

800-653-3336 • Outside the U.S. or Canada: 541-687-0213 • Fax: 541-687-2060
www.whittierwood.com • P.O. Box 2827 • Eugene, Oregon 97402, U.S.A.

**Whittier
Wood**
FURNITURE

P.O. Box 2827
Eugene, OR 97402 USA













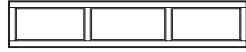



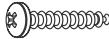







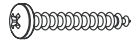

Production Code:

VN

12/10

1367AUF McKenzie Full Bookcase Headboard — Parts List

Please identify the parts and check that quantities received match those on this list.
If you need to replace a part, refer to the following letter and model name.

Part	Description		Quantity
A	Headboard Assembly		1
E	#8 x 1-1/4" Black Screw (inserted)		44
R	Assembled Door (attached)		1
S	False Bottom		3
X	Power Strip (installed)		1
Y	#8 x 7/8" Lo-Profile Screw (inserted)		4
YA	Large Adjustable Glide (installed)		2
YB	#8 x 5/8" Pan Head Screw (inserted)		8
ZA	Hinge (installed)		3
ZB	Magnetic Plate (installed)		2
ZC	Magnetic Catch (installed)		2
ZE	Door Stay (attached)		1
ZF	#6 x 5/8" Undercut Screw (inserted)		8
ZG	Door Stay Support (attached)		1
ZH	#6 x 1-1/4" Black Pan Head Screw (inserted)		3
ZI	#6 x 5/8" Flat Head Screw (inserted)		18
ZJ	#6 x 5/8" Philtruss Screw (inserted)		4
ZK	Washer		6
ZL	#12 x 1-1/4" Pan Head Screw		6
ZN	#8 x 1-1/4" Pan Head Screw (inserted)		13
ZO	#8 x 2-1/4" Black Screw (inserted)		6
ZP	#8 x 1" Black Screw (inserted)		16
ZQ	Left Bracket (attached)		2
ZR	Right Bracket (attached)		2
ZS	Wire Clip Screw (attached)		6
ZT	Tack Glide (attached)		4
ZZ	Corner Brace (attached)		2

1367AUF McKenzie Full Bookcase Headboard Assembly Instructions

Tools required: Drill, 1/8" bit, Phillips screwdriver, Slotted screwdriver

NOTE: Use this instruction and hardware kit included with this 1367 McKenzie Full Bookcase Headboard **ONLY** if you are using a Hollywood frame.

IF you are using this product with Whittier Wood Furniture Footboard and Pedestal kits, disregard this instruction and hardware and use what is included with your Footboard kit.

1. Remove the metal brackets attached to the Headboard (A).
2. Adjust the Hollywood frame to fit your mattress and box spring.
3. Place the Headboard (A) against the end brackets of the frame and mark the locations for the screws. Drill pilot holes approximately 1-1/4" deep. To make sure you don't drill deeper, measure 1-1/4" up from the end of the drill bit and wrap a piece of tape around the bit. Stop drilling when the edge of the tape meets the wood.
4. Position the Headboard (A) against the frame and attach using six #12 x 1-1/4" Pan Head Screws (ZL) and six Washers (ZK).

Fig. 5

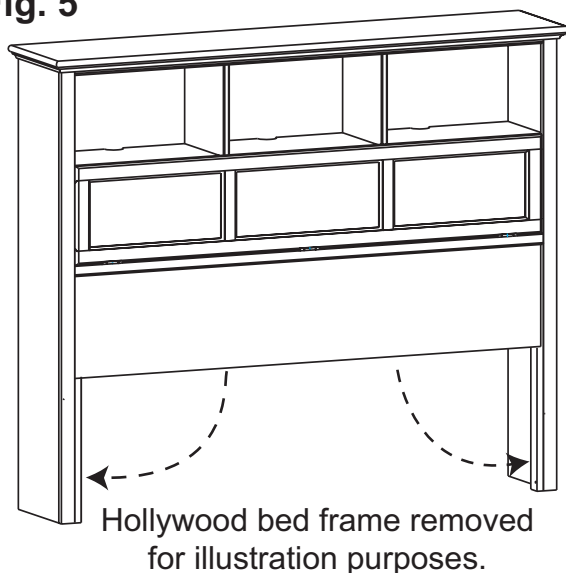

Fig. 5a

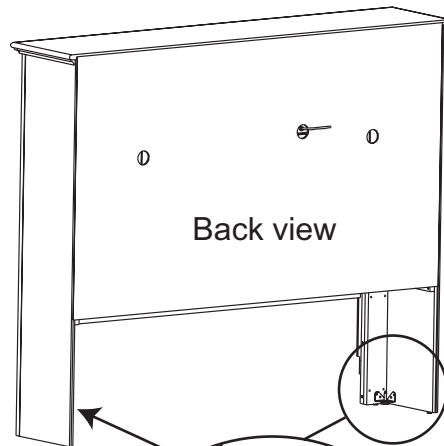
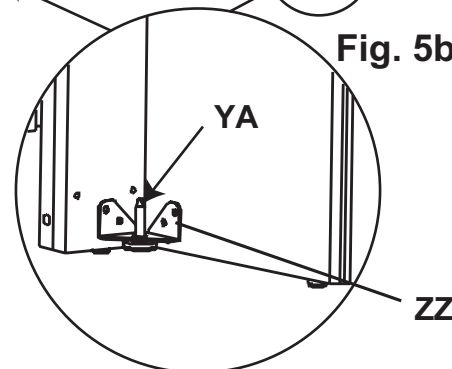

Fig. 5b



The top of the Large Adjustable Glide (YA) is slotted.

5. Place your bed in its final position. To level the headboard, reach behind the bookcase front legs and, using a slotted screwdriver, find the Large Adjustable Glide (YA). Rotate it clockwise until the Glide bears weight. See Figures 5, 5a and 5b.

THIS IS ESPECIALLY IMPORTANT IF THE BOOKCASE HEADBOARD SITS UPON A CARPET TACK STRIP.

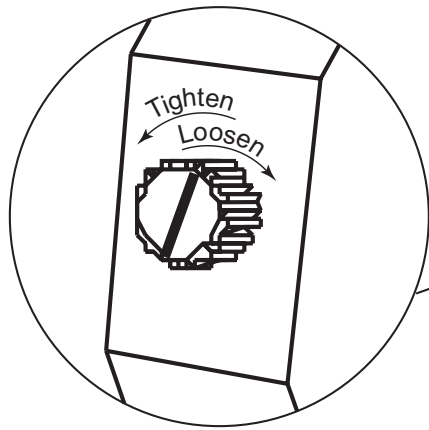

Fig. 6a

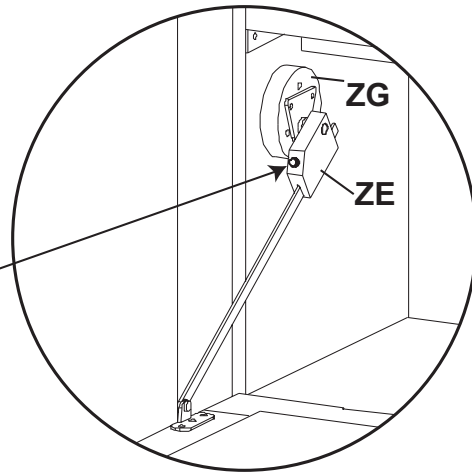

Fig. 6

6. Open the Door (R). To adjust the brake tension on the Door Stay (ZE), turn the screw on the Door Stay Support (ZG) **clockwise to loosen** or **counterclockwise to tighten**.

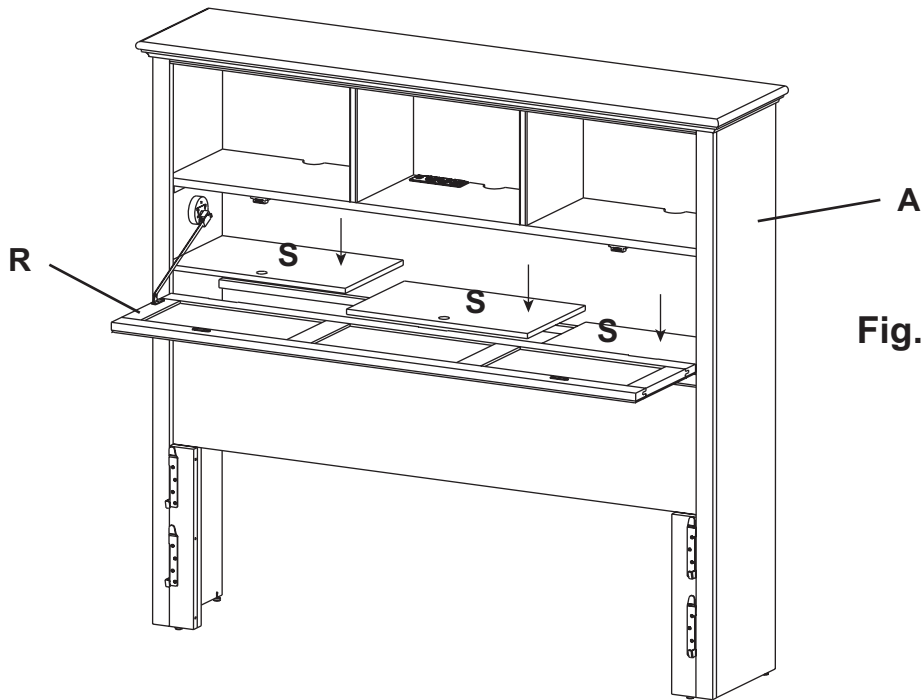

Fig. 7

7. Unwrap the False Bottoms (S) and place them on top of the rails in the Headboard Assembly (A). Make sure the finger holes face forward as shown in Figure 7.

After you have placed your electronics inside the cubbies, use the Wire Clips (ZS) found on the undersides of the cubbies to secure the wires.

8. Close the door tightly, making sure the magnetic catches and plates securely touch.

Finishing Hints

Choosing the Finish:

1. Choose a finish that will meet your expectations for the product you are finishing. Are you matching existing furniture or do you want a "natural" finish? Is the piece to be functional, decorative or both? The answers to these questions may affect the type of finish you choose.
2. Use products of the same brand to ensure compatibility of products.
3. **ALWAYS** follow the stain manufacturer's instructions. Alder is a porous hardwood and often looks best when following the finishing directions for softwoods
4. We recommend using a wood conditioner under oil base stains.
5. Work in a well ventilated and well lit area.

Getting Started

1. **Assembly Instructions may contain special finishing information for that item.** Read both the Assembly Instructions and these Finishing Hints completely before beginning.
2. Sand the entire piece, using #220 grit sandpaper. Sand with the grain of the wood on flat surfaces and opposite the grain on turnings. Some parts are plywood. Be careful not to sand through the veneer. End grain (table top ends, seat edges, grooves on turnings, etc.) accepts more stain. Extra sanding in these areas with a #320 grit sandpaper will reduce stain absorption, creating a more evenly stained piece.
3. When sanding is completed, wipe the surface of your furniture with a cloth or tack rag. Make sure the item is free of dust before proceeding.

Staining

1. Read and follow label directions. Stir stain well before starting.
2. Test stain on an inconspicuous spot on your project, or use the sample chip if one is provided. The sample chip must be sanded in the same way as your furniture kit to ensure the piece will accept the stain similarly. Put at least one coat of your top coat over the stain sample, as it also affects the look of the stain. **Test every type of wood that is in your kit.** Some of our products include more than one type of wood, which may react differently to the stain color. Sample chips for the different woods may be included. It may be necessary to add a second coat of stain to lighter woods to match the darker woods in your kit.

Basic Equipment:

- | | | |
|----------------------------------------|-----------------------------------------------------------|------------------------------------------------|
| <input type="checkbox"/> Rubber gloves | <input type="checkbox"/> Tack cloth | <input type="checkbox"/> #220 & #320 sandpaper |
| <input type="checkbox"/> Rags | <input type="checkbox"/> Drop cloth | <input type="checkbox"/> Mineral spirits |
| <input type="checkbox"/> Paper towels | <input type="checkbox"/> Paint brushes (bristle and foam) | <input type="checkbox"/> Masking Tape |
| <input type="checkbox"/> Q-tips | | |

3. Apply stain with a poly brush or lint-free cloth. Apply stain over a small area and wipe off excess. Working in small areas will make the color easier to control.
4. Q-tips are ideal for hard to reach areas.
5. Allow to dry thoroughly before proceeding.

Applying the Top Coat:

No top coat is required if using paint.

1. **Always read and follow all label directions.** Stir your finish coat gently, **do not shake.** It will create bubbles that are hard to remove.
2. **All surfaces** (including the underside of table tops and inside drawers) **must be sealed with at least one layer of a top coat.** This will help minimize wood swelling, shrinkage, warping and cupping due to changes in moisture content or temperature.
3. We recommend that you **apply a minimum of two coats when using polyurethane or varnish (especially on all table top and work surfaces).** Sand lightly between coats using a #320 grit sandpaper or 00 steel wool for the smoothest possible finish.
4. Some water-based finishes tend to raise the grain slightly. This can be easily controlled with this sanding step. However, do not use steel wool when using water-based finishes. Strands of steel fiber caught in the wood can cause rust spots when coated with any water-based product.

Painting:

1. For best results when painting, first coat the wood with a primer. An oil based primer would be best for a smooth finish. If you do not wish to use a solvent based primer, a water based primer would work almost as well.
2. Buy a quality brand paint. You may use a satin, semi-gloss, or gloss sheen. Apply a second coat for a smooth finish. Lightly sand between coats using a #320 grit sandpaper, so that the second coat will bond well. Repeat as desired.
3. Since there is such a variation between paint manufacturers, refer to your paint supplier for specific advice on using the paint that you purchase.