

Model #

1367AFGAC; 1367AFCAF

McKenzie Full Bookcase Headboard

AFGAC = Glazed Antique Cherry finish

AFCAF = Caffè finish

Assembly Instructions

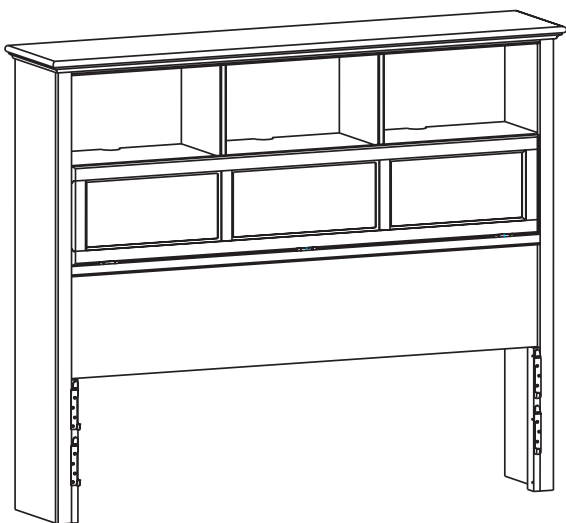

Congratulations!

This fine piece of furniture will make a gorgeous addition to your home. For the best results, read the Assembly Instructions before you begin your project.

IMPORTANT NOTES:

- For normal household use only. **Not** recommended for commercial use.
- Unload items before you move this unit.
- Before you load or move this unit, tighten all screws and supports.
- Do not overload the concealed storage areas.
- Do not overload the cubbies.
- Before you begin your project, completely read the Assembly Instructions.
- Store this item: 1- in its box; 2- in a dry place; 3- in temperatures that range from 40°F to 90°F (not on a cold and possibly damp cement floor).
- Periodically inspect your furniture for any loose glue joints, screws or any other problem that might affect the stability of your furniture. Tighten or repair as needed.
- This assembly requires two people.

DESIGN SUBJECT TO CHANGE WITHOUT NOTICE.



CALL US FIRST! *Do not return this item to the store.*

Service Policy: We will replace any part that is defective, missing or damaged during assembly. For a replacement part, contact Whittier Wood Products customer service department by phone, fax, mail or email.

Hours: Our friendly customer service staff can be reached Monday-Friday 7:00 a.m. to 5:00 p.m. (Pacific Time). You may leave a message 24 hours a day, seven days a week.

To Order: Provide the finish and furniture model number (upper portion of this page), the part letter, production code, quantity needed, reason for replacement and your full name, address and telephone number.

Parts ship from our Eugene, Oregon factory within one or two business days from the time we receive your request. Please allow five to ten business days for delivery.

800-653-3336 • Outside the U.S. or Canada: 541-687-0213 • Fax: 541-687-2060
www.whittierwood.com • P.O. Box 2827 • Eugene, Oregon 97402, U.S.A.

**Whittier
Wood**
FURNITURE

P.O. Box 2827
Eugene, OR 97402 USA

Production Code:

VN













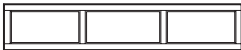



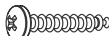



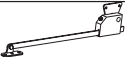

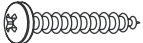

12/10

1367AFGAC; 1367AFCAF

McKenzie Full Bookcase Headboard — Parts List

Please identify the parts and check that quantities received match those on this list.

If you need to replace a part, refer to the following letter and model name.

Part	Description		Quantity
A	Headboard Assembly		1
E	#8 x 1-1/4" Black Screw (inserted)		44
R	Assembled Door (attached)		1
S	False Bottom		3
X	Power Strip (installed)		1
Y	#8 x 7/8" Lo-Profile Screw (inserted)		4
YA	Large Adjustable Glide (installed)		2
YB	#8 x 5/8" Pan Head Screw (inserted)		8
ZA	Hinge (installed)		3
ZB	Magnetic Plate (installed)		2
ZC	Magnetic Catch (installed)		2
ZE	Door Stay (attached)		1
ZF	#6 x 5/8" Undercut Screw (inserted)		8 (AFGAC) 26 (AFCAF)
ZG	Door Stay Support (attached)		1
ZH	#6x1-1/4" Black Pan Head Screw (inserted)		3
ZI	#6 x 5/8" Flat Head Screw (inserted)		18 (AFGAC) 0 (AFCAF)
ZJ	#6 x 5/8" Philtruss Screw (inserted)		4
ZK	Washer		6
ZL	#12 x 1-1/4" Pan Head Screw		6
ZN	#8 x 1-1/4" Pan Head Screw (inserted)		13
ZO	#8 x 2-1/4" Black Screw (inserted)		6
ZP	#8 x 1" Black Screw (inserted)		16
ZQ	Left Bracket (attached)		2
ZR	Right Bracket (attached)		2
ZS	Wire Clip Screw (attached)		6
ZT	Tack Glide (attached)		4
ZZ	Corner Brace (attached)		2

1367AFGAC; 1367AFCAF McKenzie Full Bookcase Headboard Assembly Instructions

Tools required: Drill, 1/8" bit, Phillips screwdriver, Slotted screwdriver

NOTE: Use this instruction and hardware kit included with this 1367 McKenzie Full Bookcase Headboard ONLY if you are using a Hollywood frame.

IF you are using this product with Whittier Wood Furniture Footboard and Pedestal kits, disregard this instruction and hardware and use what is included with your Footboard kit.

1. Remove the metal brackets attached to the Headboard (A).
2. Adjust the Hollywood frame to fit your mattress and box spring.
3. Place the Headboard (A) against the end brackets of the frame and mark the locations for the screws. Drill pilot holes approximately 1-1/4" deep. To make sure you don't drill deeper, measure 1-1/4" up from the end of the drill bit and wrap a piece of tape around the bit. Stop drilling when the edge of the tape meets the wood.
4. Position the Headboard (A) against the frame and attach using six #12 x 1-1/4" Pan Head Screws (ZL) and six Washers (ZK).

Fig. 5

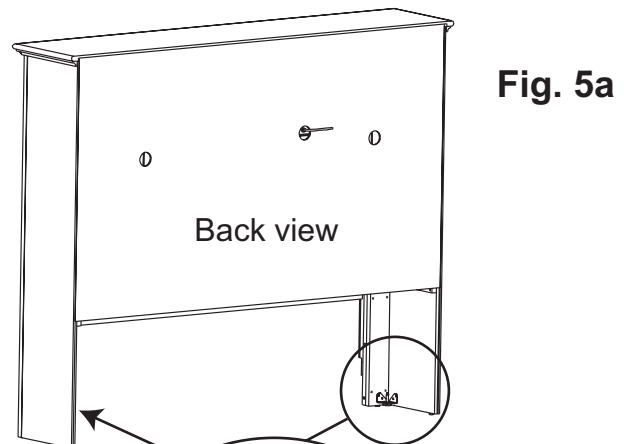
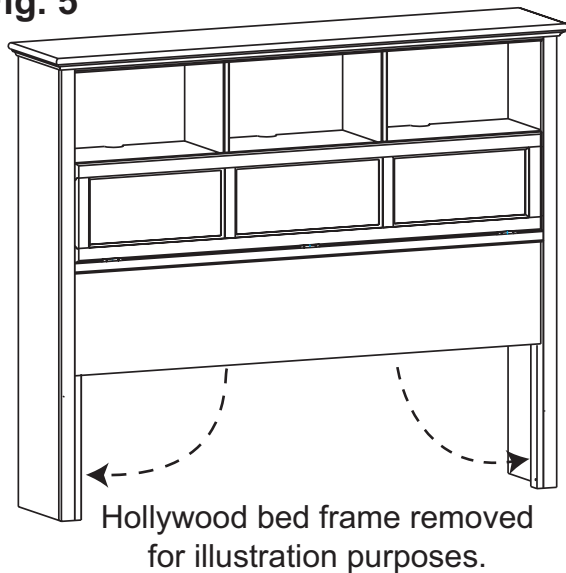

Fig. 5a

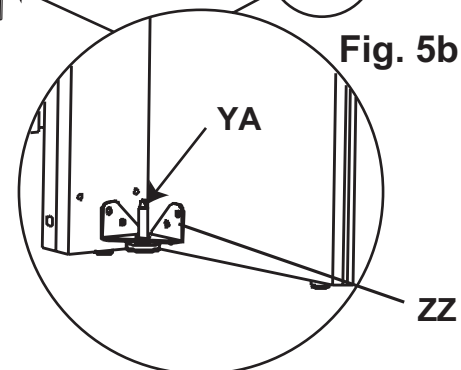

Fig. 5b

The top of the Large Adjustable Glide (YA) is slotted.

5. Place your bed in its final position. To level the headboard, reach behind the bookcase front legs and, using a slotted screwdriver, find the Large Adjustable Glide (YA). Rotate it clockwise until the Glide bears weight. See Figures 5, 5a and 5b.

THIS IS ESPECIALLY IMPORTANT IF THE BOOKCASE HEADBOARD SITS UPON A CARPET TACK STRIP.

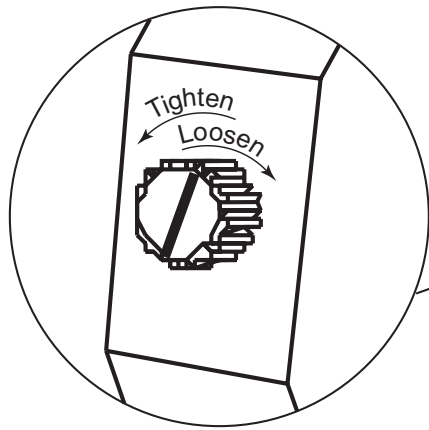

Fig. 6a

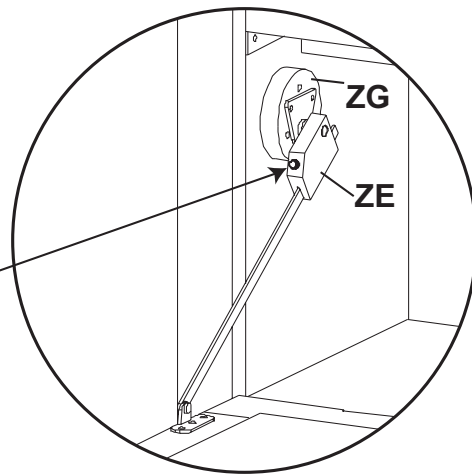

Fig. 6

6. Open the Door (R). To adjust the brake tension on the Door Stay (ZE), turn the screw on the Door Stay Support (ZG) **clockwise to loosen** or **counterclockwise to tighten**.

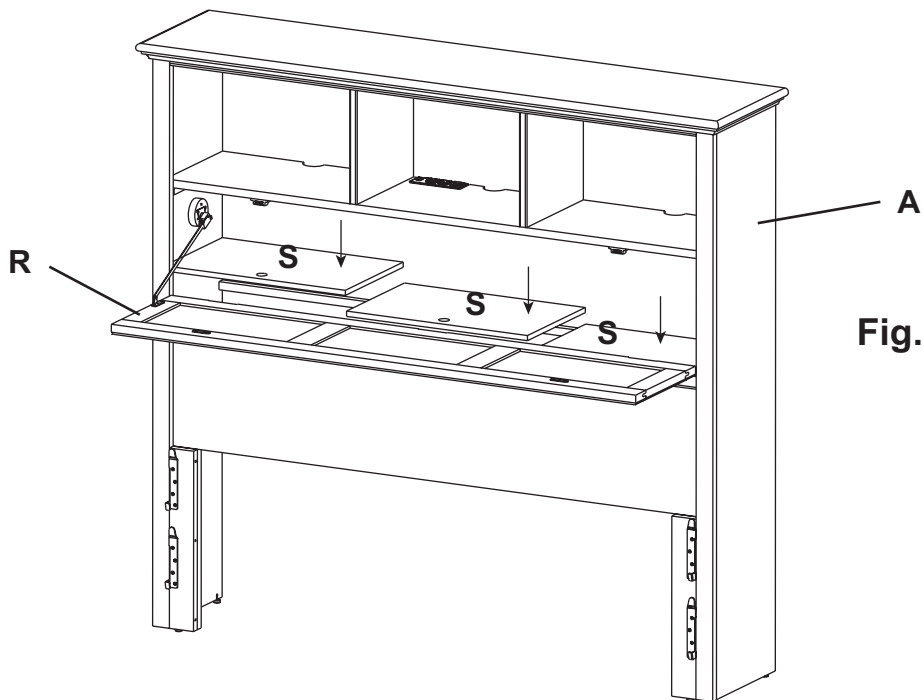

Fig. 7

7. Unwrap the False Bottoms (S) and place them on top of the rails in the Headboard Assembly (A). Make sure the finger holes face forward as shown in Figure 7.

After you have placed your electronics inside the cubbies, use the Wire Clips (ZS) found on the undersides of the cubbies to secure the wires.

8. Close the door tightly, making sure the magnetic catches and plates securely touch.