

Model #

# 1333AUFb

## McKenzie Cal-King Storage Bed

Assembly Instructions

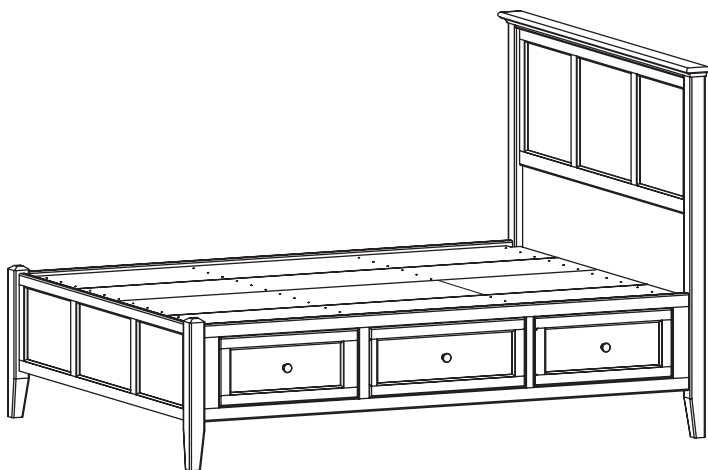

### Congratulations!

*This fine piece of furniture will make a gorgeous addition to your home. For the best results, read the Assembly Instructions and Finishing Hints before you begin your project.*

### IMPORTANT NOTES:

- For normal household use only. **Not** recommended for commercial use.
- Remove items before you move this unit.
- Before you load or move this item, tighten all screws and supports.
- Do not overload the drawers in this unit.
- Before you begin your project, completely read the Assembly Instructions and Finishing Hints.
- Store this item: 1- in its box; 2- in a dry place; 3- in temperatures that range from 40° F to 90° F (not on a cold and possibly damp cement floor).
- Periodically inspect your furniture for any loose glue joints, screws or any other problem that might affect the stability of your furniture. Tighten or repair as needed.
- This assembly requires two people.

**DESIGN SUBJECT TO CHANGE WITHOUT NOTICE.**



**CALL US FIRST!** *Do not return this item to the store.*

**Service Policy:** We will replace any part that is defective, missing or damaged during assembly. For a replacement part, directly contact Whittier Wood Products customer service department by phone, fax, mail or email.

**Hours:** Our friendly customer service staff can be reached Monday-Friday 7:00 a.m. to 5:00 p.m. (Pacific Time). You may leave a message 24 hours a day, seven days a week.

**To Order:** Provide the furniture model number (upper portion of this page), the part letter, production code, quantity needed, reason for replacement and your full name, address and telephone number.

*Parts ship from our Eugene, Oregon factory within one or two business days from the time we receive your request. Please allow five to ten business days for delivery.*

**800-653-3336** • Outside the U.S. or Canada: 541-687-0213 • Fax: 541-687-2060  
www.whittierwood.com • P.O. Box 2827 • Eugene, Oregon 97402, U.S.A.

**Whittier  
Wood**  
FURNITURE

P.O. Box 2827  
Eugene, OR 97402 USA

Production Code:











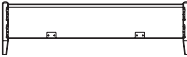





VN

12/10

# 1333AUFb McKenzie Cal-King Storage Bed — Parts List

Please identify the parts and check that quantities received match what is on this list.  
If you need to replace a part, refer to the following letter and item name.

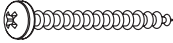











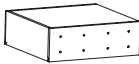



## 1336AUFa Headboard/Footboard Kit (x1)

Part	Description		Quantity
A	Headboard Assembly		1
Ba	Footboard Assembly		1
Da	Trestle With T-Nuts		7
E	#8 x 1-1/4" Black Screw		45 (9 inserted)
F	1/4" x 1-3/4" Hex Bolt		26
H	Washer		26
R	Long Center Deckboard		1
S	Short Center Deckboard		1
Ua	Foot Assembly		3
W	Adjustable Glide (installed)		3
YD	#6 x 1/2" Philtruss Screw		8
YF	90° Bracket		2
ZP	#8 x 1" Black Screw (inserted)		32
ZQ	Left Bracket (attached)		4
ZR	Right Bracket (attached)		4
ZU	1/4" T-Nut (inserted)		28
ZV	#8 x 20mm Pan Head Screw (inserted)		12
ZX	#8 x 1-5/8" Black Screw (inserted)		8
ZY	Foot Bracket (attached)		3

# 1333AUFb McKenzie Cal-King Storage Bed — Parts List

Please identify the parts and check that quantities received match what is on this list.  
If you need to replace a part, refer to the following letter and item name.

## 1335AUFb Pedestal Kit (x2)

Part	Description	Quantity
E	#8 x 1-1/4" Black Screw (inserted) 	32
lb	Pedestal Kit 	1
J	Drawer Box (assembled) 	3
L	Drawer Face (attached) 	3
N	#8 x 1-1/2" Machine Screw (installed) 	3
O	Knob (attached) 	3
P	Deckboard 	1
Q	Drawer Slides (installed) 	3 sets
T	#8 x 2" Black Screw (inserted) 	12
Y	#8 x 7/8" Lo-Profile Screw (inserted) 	24
YD	#6 x 1/2" Philtruss Screw (inserted) 	18
YE	#6 x 3/4" Philtruss Screw (inserted) 	18
ZP	#8 x 1" Black Screw (inserted) 	16
ZQ	Left Bracket (attached) 	2
ZR	Right Bracket (attached) 	2
ZX	#8 x 1-5/8" Black Screw (inserted) 	16

# 1333AUFb McKenzie Cal-King Storage Bed Assembly Instructions

This assembly requires two people

**Tools Required:** Phillips screwdriver, 7/16" open end or box end wrench and Tape measure

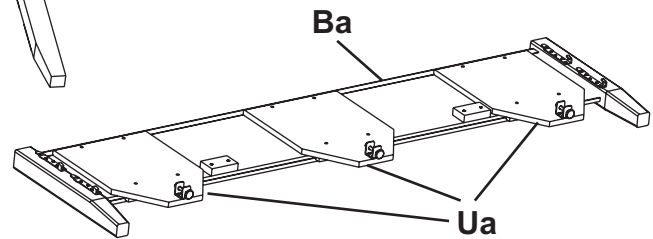
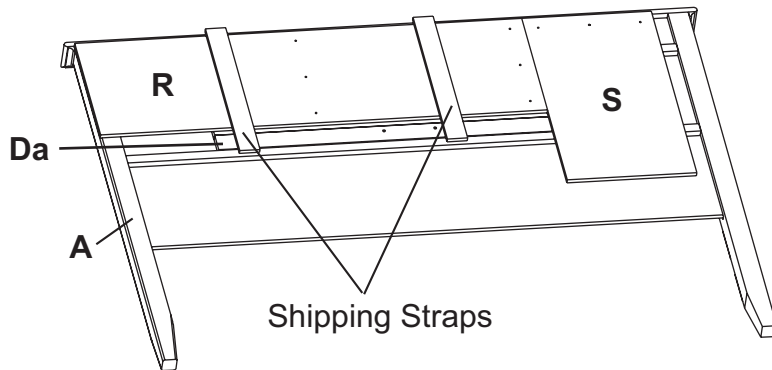

1. Remove the Trestles (Da), the Long Center Deckboard (R), the Short Center Deckboard (S) and Foot Assemblies (Ua) from the back of the Headboard (A) and Footboard (Ba) as seen in Figure 1 and 1a and place them off to the side.

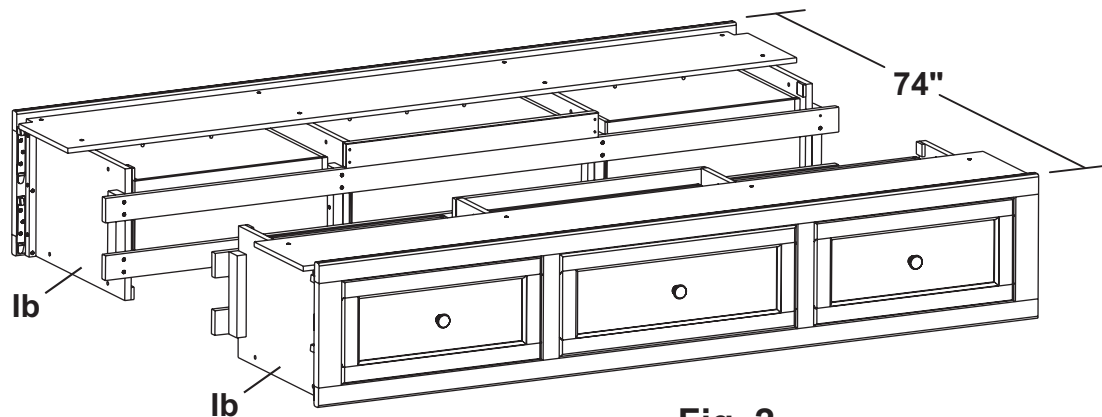

2. Place both Pedestals (lb) approximately 74" apart as shown in Figure 2.