

Model #

# 1153GBCH

## Cascade

### 9-Drawer Dresser

#### Glazed Black Cherry finish

*Assembly Instructions*



#### IMPORTANT NOTES:

- For normal household use only. *Not* recommended to use this product in a commercial setting.
- Do not climb, sit or stand on or in this piece of furniture.
- Do not overload the drawers.
- Unload items before you move this unit.
- Before you load or move this unit, tighten all screws and supports.
- Before you begin your project, completely read the Assembly Instructions.
- Store this item: 1- in its box; 2- in a dry place; 3- in temperatures that range from 40°F to 90°F (not on a cold and possibly damp cement floor).
- Periodically inspect your furniture for any loose glue joints, screws or any other problem that might affect the stability of your furniture. Tighten or repair as needed.

#### WARNING

**Serious or fatal crushing injuries can occur from furniture tip-over. To help prevent tip-over:**

- Place heaviest items in the bottom drawers.
- Unless specifically designed to accommodate, do not set TVs or other heavy objects on top of this product.
- Never allow children to climb or hang on drawers, doors or shelves.
- Never open more than one drawer at a time.

**Properly installing tip-over restraints may reduce but does not eliminate the risk of tip-over.**

**DESIGN SUBJECT TO CHANGE WITHOUT NOTICE**

#### **Congratulations!**

*This fine piece of furniture will make a gorgeous addition to your home. For the best results, read the Assembly Instructions before you begin your project.*



**CALL US FIRST! Do not return this item to the store**

**Service Policy:** We will replace any part that is defective, missing or damaged during assembly. For a replacement part, contact Whittier Wood Products customer service department by phone, fax, mail or email.

**Hours:** Our friendly customer service staff can be reached Monday-Friday 7:00 a.m. to 5:00 p.m. (Pacific Time). You may leave a message 24 hours a day, seven days a week.

**To Order:** Provide the furniture model number (upper portion of this page), the part letter, production code, quantity needed, reason for replacement and your full name, address and telephone number.

*Parts ship from our Eugene, Oregon factory within one or two business days from the time we receive your request. Please allow five to ten business days for delivery*

**800-653-3336** • Outside the U.S. or Canada: 541-687-0213 • Fax: 541-687-2060  
www.whittierwood.com • P.O. Box 2827 • Eugene, Oregon 97402, U.S.A.



P.O. Box 2827  
Eugene, OR 97402 USA

Production Code:











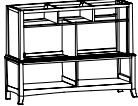



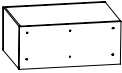



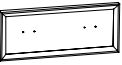

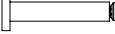

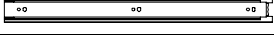

VN

08/11



# 1153GBCH Cascade 9-Drawer Dresser

## Parts List

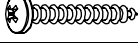
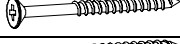
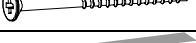
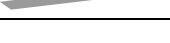
Please identify the parts and check that quantities received match those on this list.  
If you need to replace a part, refer to the following letter(s) and part name.

Part	Description		Quantity
A	Top Assembly		1
B	Case		1
C	Top Left/Right Drawer Box (inserted)		2
D	Top Center Drawer Box (inserted)		1
E	Middle Drawer Box (inserted)		4
F	Bottom Drawer Box (inserted)		2
G	Small Upper Drawer Face (installed)		3
H	Medium Upper Drawer Face (installed)		2
I	Large Upper Drawer Face (installed)		2
J	Bottom Drawer Face (installed)		2
K	Tray (inserted)		1
L	Assembled Foot (attached)		1
N	Small Adjustable Glide (installed)		5
O	Small Pull (attached)		11
P	#8 x 1-1/2" Machine Screw (installed)		22
Q	Large Pull (attached)		4
R	#8 x 1-1/4" Machine Screw (installed)		8
S	Drawer Slides (pre-installed sets)		9
T	#6 x 1/2" Philtruss Screw (inserted)		54
U	#6 x 3/4" Philtruss Screw (inserted)		54
V	Hinge (attached)		1
W	#6 x 5/8" Undercut Screw (inserted)		2
X	Hex Bumper (attached)		2
Y	M4 x 10mm Insert Nut (inserted)		4
ZA	#8 x 7/8" Lo-Profile Screw (inserted)		48
ZB	#8 x 1-1/4" Pan Head Screw (inserted)		32
ZD	#8 x 1-1/4" Black Screw (inserted)		6
ZE	#8 x 1-5/8" Black Screw (inserted)		4
ZF	Pad Strip (attached)		1

**1153GBCH Cascade 9-Drawer Dresser**  
*Parts List*

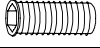
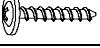
<b>Part</b>	<b>Description</b>	<b>Quantity</b>
ZG	Small Velvet (attached) 	1
ZH	Large Velvet (attached) 	1
ZJ	#8 x 2" Black Screw (inserted) 	2
ZK	1/4" x 20mm Insert Nut (inserted) 	5
ZL	#8 x 1-1/8" Lo-Profile Screw (inserted) 	4
TR	Furniture Tipping Restraint	2 sets

# 1153GBCH Cascade 9-Drawer Dresser

## Assembly Instructions

### Tool Required: Phillips Screwdriver

1. Open the Center Drawer (D) and remove the foam packaging. Remove the Tray (K) from the drawer and recycle the packaging. Return the Tray (K) to the drawer. See Figure 1.

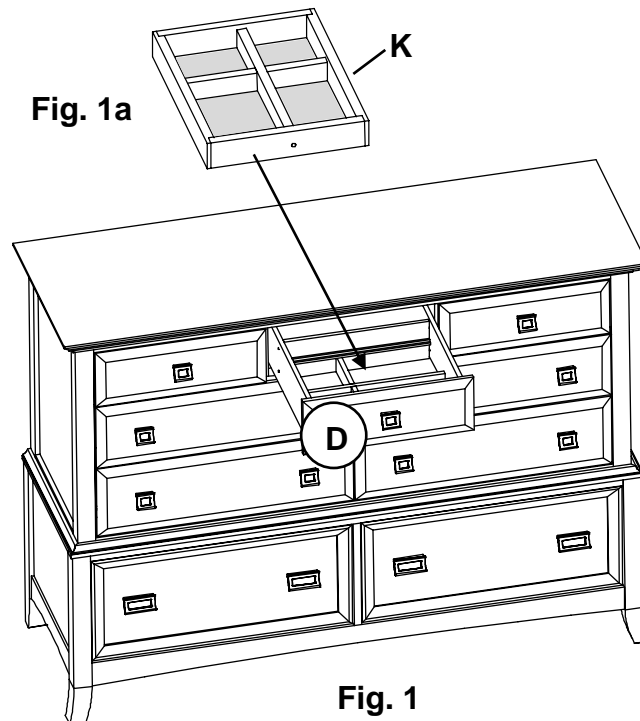

2. There is a secret storage area in the Center Drawer (D). To access this storage, open the upper right Middle Drawer (E). Reach in until you find the Hinge (V) that is attached to the bottom of the Center Drawer (D). Pull the Hinge (V) forward and then pull the center drawer (D) out far enough so you can access the concealed storage space. To close the drawer, just push it shut. See Figure 2.

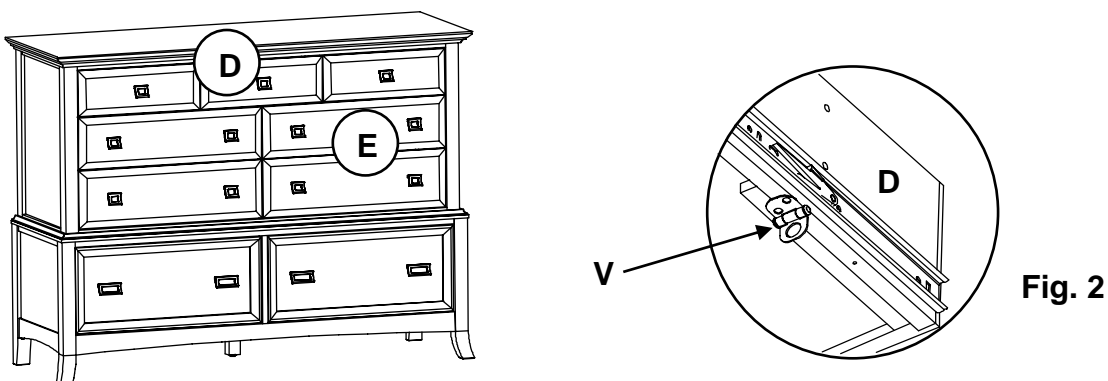

# 1153GBCH Cascade 9-Drawer Dresser

## Assembly Instructions

3. Place the chest at its final destination. Rotate the Small Adjustable Glides (N) on the bottoms of the legs and Assembled Foot (L) until the unit is level. See Figure 3.

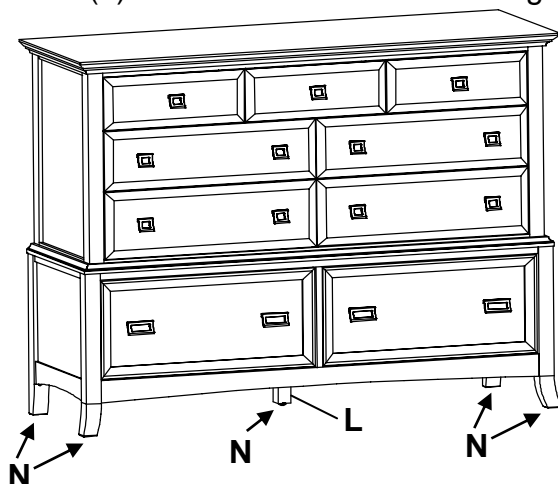

Fig. 3

4. **Tipping restraint:** Locate two studs in the wall behind the unit. Attach a Clip (T1) to one wall stud with two #8 x 2" Black Screws (T3). See Figure 4a. Attach a second clip to the unit with two #8 x 1" Pan Head Screws (T4). See Figure 4b. Connect the two clips with the Nylon Restraint Strap (T2). Pull the Nylon Restraint Strap (T2) tight so there is no slack. See Figures 4c and 4d. Repeat this procedure to attach the second tipping restraint. If you cannot locate two studs, purchase the proper wall attachment hardware for your type of wall and secure the unit.

