

Pacific Blanket Dresser

Model #

1141AFGSP; 1141AFCAF

AFGAC = Glazed Spice finish

AFCAF = Caffè finish

Assembly Instructions

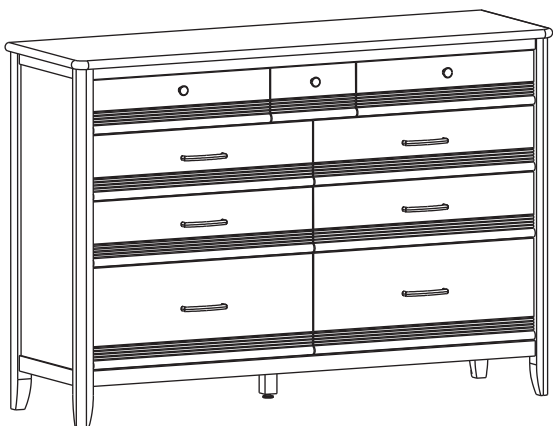

Congratulations!

This fine piece of furniture will make a gorgeous addition to your home. For the best results, read the Assembly Instructions before you begin your project.

WARNING!

Serious or fatal crushing injuries can occur from furniture tip-over. To help prevent tip-over:

- Place heaviest items in the bottom drawers.
- Unless specifically designed to accommodate, do not set TVs or other heavy objects on top of this product.
- Never allow children to climb or hang on drawers, doors or shelves.
- Never open more than one drawer at a time.

Use of tip-over restraints may only reduce but not eliminate the risk of tip-over.

IMPORTANT NOTES:

- For normal household use only. **Not** recommended for commercial use.
- Do not climb, sit or stand on this piece of furniture.
- Unload items before you move this unit.
- Before you load or move this unit, make sure all screws and supports are tight.
- Before you begin your project, completely read the Assembly Instructions.
- Store this item: 1- in its box; 2- in a dry place; 3- in temperatures that range from 40°F to 90°F (not on a cold and possibly damp cement floor).
- Periodically inspect your furniture for any loose glue joints, screws or any other problem that might affect the stability of your furniture. Tighten or repair as needed.

DESIGN SUBJECT TO CHANGE WITHOUT NOTICE.



CALL US FIRST! *Do not return this item to the store.*

Service Policy: We will replace any part that is defective, missing or damaged during assembly. For a replacement part, directly contact Whittier Wood Products customer service department by phone, fax, mail or email.

Hours: Our friendly customer service staff can be reached Monday-Friday 7:00 a.m. to 5:00 p.m. (Pacific Time). You may leave a message 24 hours a day, seven days a week.

To Order: Provide the finish, the furniture model number (upper left corner of this page), part letter, production code, quantity needed, reason for replacement, your full name, address and telephone number.

Parts ship from our Eugene, Oregon factory within one or two business days from the time we receive your request. Please allow five to ten business days for delivery.

800-653-3336 • Outside the U.S. or Canada: 541-687-0213 • Fax: 541-687-2060
www.whittierwood.com • P.O. Box 2827 • Eugene, Oregon 97402, U.S.A.

**Whittier
Wood**
FURNITURE

P.O. Box 2827
Eugene, OR 97402 USA

Production Code:











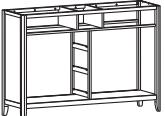













VN

09/10

1141AFGSP; 1141AFCAF Pacific Blanket Dresser – Parts List







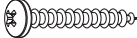
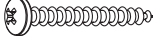

Please identify the parts and check that quantities received match what is on this list.

If you need to replace a part, refer to the following letter and item name.

Part	Description	Quantity
A	Top (attached) 	1
B	Case 	1
C	Large Left Drawer (inserted) 	1
D	Large Right Drawer (inserted) 	1
E	Medium Left Drawer (inserted) 	2
F	Medium Right Drawer (inserted) 	2
G	Center Drawer with secret storage (inserted) 	1
H	Small Left Drawer (inserted) 	1
I	Small Right Drawer (inserted) 	1
J	Large Drawer Face (installed) 	2
K	Medium Drawer Face (installed) 	4
L	Small Drawer Face (installed) 	2
M	Center Drawer Face (installed) 	1
N	Knob (attached) 	3
O	Handle (attached) 	6
P	4x41mm Machine Screw (inserted) 	15
Q	Drawer Slides (installed) 	9 sets
R	#6 x 1/2" Philtruss Screw (inserted) 	54
S	#6 x 3/4" Philtruss Screw (inserted) 	54
V	Hinge (attached) 	1
U	#6x5/8" Flat Head Screw (inserted) 	2
T	T-Nut (inserted) 	5
W	Small Adjustable Glide (installed) 	4
X	Adjustable Glide (installed) 	1
Y	Assembled Foot (attached) 	1

1141AFGSP; 1141AFCAF Pacific Blanket Dresser — Parts List continued

Please identify the parts and check that quantities received match what is on this list.
If you need to replace a part, refer to the following letter and item name.

Part	Description	Quantity
ZA	#8x1" Lo-Profile Screw (inserted) 	48
ZB	#8x1-3/16" Pan Head Screw (inserted) 	4
ZC	#8x1-1/4" Pan Head Screw (inserted) 	14
ZD	#8x1-3/4" Pan Head Screw (inserted) 	10
ZE	#8x1-5/8" Black Screw (inserted) 	6
ZF	#8x1-1/4" Black Screw (inserted) 	64
ZG	#8x1" Black Screw (inserted) 	16
ZH	#8x2" Black Screw (inserted) 	1
ZI	Hex Bumper (attached) 	2
ZJ	Pad (attached) 	1
TR	Furniture Tipping Restraint	2 sets

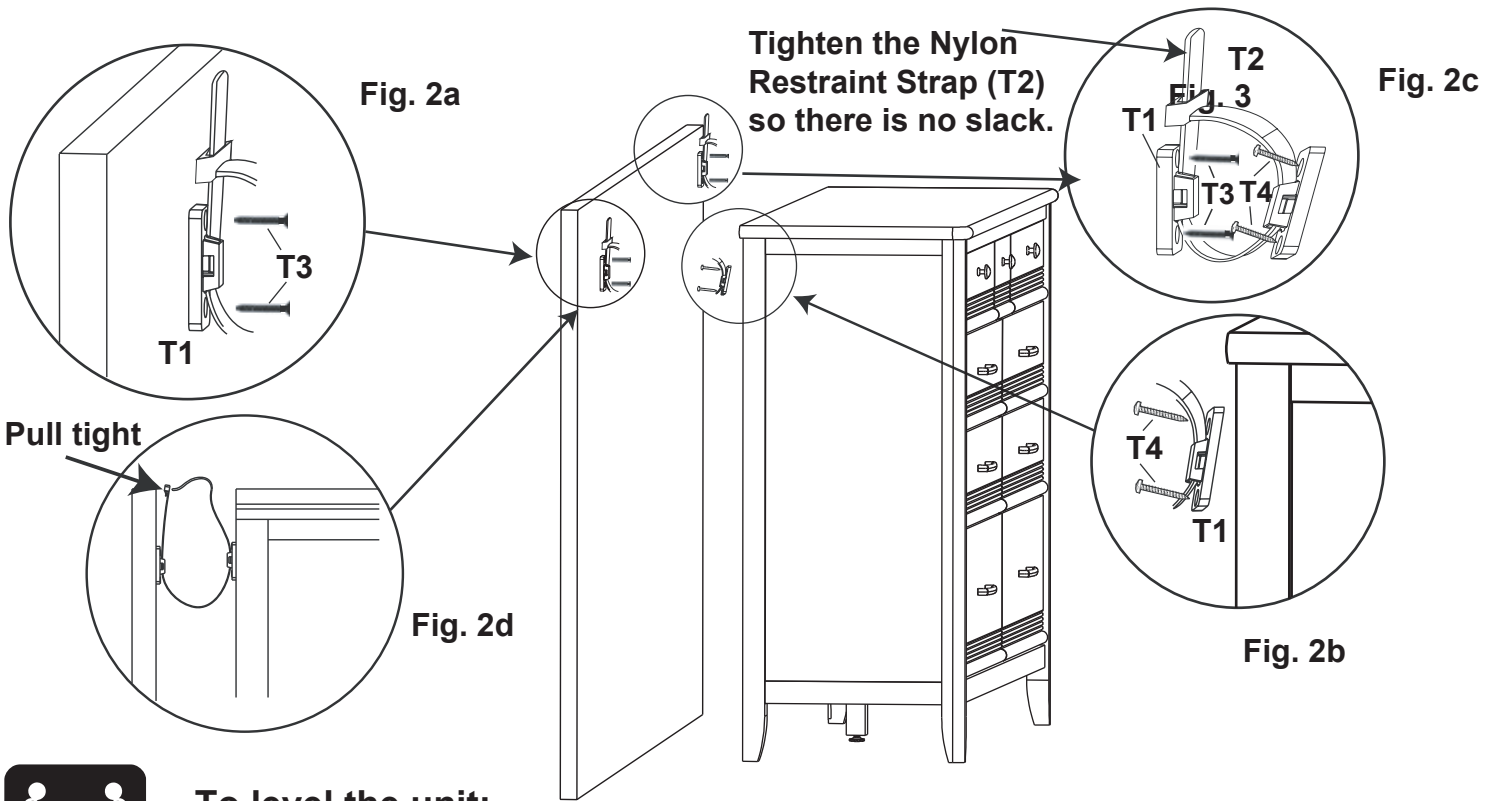

To level the unit:

1. Position the unit at the desired location. Adjustable Glides (W and X) are attached to the bottoms of the legs and the Foot Assembly (Y). Rotate the glides until the unit stands level.

Tipping restraint:

2. Locate two studs in the wall behind the unit. Attach a Clip (T1) to one wall stud with two #8 x 2" Black Screws (T3). See Figure 2a. Attach a second clip to the unit with two #8 x 1" Pan Head Screws (T4). See Figure 2b. Connect the two clips with the Nylon Restraint Strap (T2). **Pull the Nylon Restraint Strap (T2) tight so there is no slack.** See Figures 2c and 2d. Repeat this procedure to attach the second tipping restraint. If you cannot locate two studs, purchase the proper wall attachment hardware for your type of wall and secure the unit.

Unless specifically designed to accommodate, do not set TVs or other heavy objects on top of this product.

This unit has concealed storage. To access:

3. There is a secret storage area in the center drawer (G). To access this storage, open the top right medium drawer (F). Reach in until you find the Hinge (V) that is attached to the bottom of the center drawer. Pull the Hinge forward and then pull the center drawer (G) out far enough so you can access the concealed storage space. To close the drawer, just push it shut. See Figure 3.

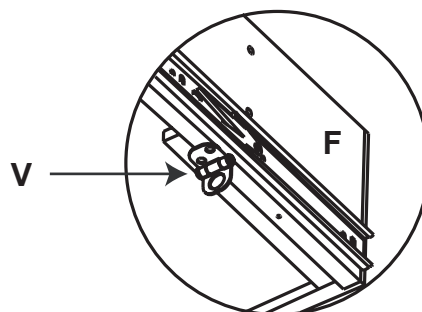
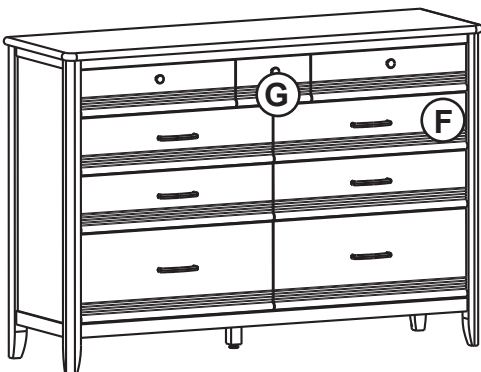

Fig. 3