

# Cascade Nightstand

*Glazed Black Cherry finish*

*Assembly Instructions*

Model #

## 1106GBCH Small 3-Drawer Nightstand

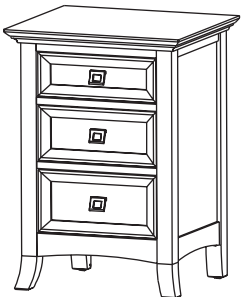

Model #

## 1108GBCH 3-Drawer Nightstand



### ***Congratulations!***

*This fine piece of furniture will make a gorgeous addition to your home. For the best results, read the Assembly Instructions before you begin your project.*

## **! WARNING**

**Serious or fatal injuries can occur from furniture tip-over. To help prevent tip-over:**

- Place heaviest items in the bottom drawers.
- Unless specifically designed to accommodate, do not set a TV or any other heavy object on top of this product.
- Never allow children to climb or hang on drawers, doors or shelves.
- Never open more than one drawer at a time.

**Properly installing tipping restraints can reduce but does not eliminate the risk of tip-over.**

## **! IMPORTANT NOTES:**

- For normal household use only. **Not** recommended for commercial use.
- Before you begin your project, completely read the Assembly Instructions.
- Before you load or move this unit, tighten all screws and supports.
- Unload items before you move this unit.
- Store this item: 1- in its box; 2- in a dry place; 3- in temperatures that range from 40°F to 90°F (not on a cold and possibly damp cement floor).
- Periodically inspect your furniture for any loose glue joints, screws or any other problem that might affect the stability of your furniture. Tighten or repair as needed.

**DESIGN SUBJECT TO CHANGE WITHOUT NOTICE.**



**CALL US FIRST!** *Do not return this item to the store.*

**Service Policy:** We will replace any part that is defective, missing or damaged during assembly. For a replacement part, phone, fax, mail or email the Whittier Wood Products customer service department.

**Hours:** Our friendly customer service staff can be reached Monday-Friday 7:00 a.m. to 5:00 p.m. (Pacific Time). You may leave a message 24 hours a day, seven days a week.

**To Order:** Provide the finish, the furniture model number (to the left of the illustration), the part letter, production code, quantity needed, reason for replacement and your full name, address and telephone number.

*Parts ship from our Eugene, Oregon factory within one or two business days from the time we receive your request. Please allow five to ten business days for delivery.*

**800-653-3336** • Outside the U.S. or Canada: 541-687-0213 • Fax: 541-687-2060  
www.whittierwood.com • P.O. Box 2827 • Eugene, Oregon 97402, U.S.A.

**Whittier  
Wood**  
FURNITURE

P.O. Box 2827  
Eugene, OR 97402 USA

Production Code:













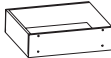

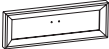
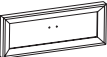
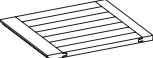

VN

05/11

# 1106GBCH and 1108GBCH Cascade Nightstand – Parts List

Please identify the parts and check that quantities received match what is on this list.

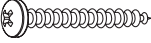
If you need to replace a part, refer to the following letter and item name.

Part	Description	Quantity	
		1106GBCH	1108GBCH
A	Top Assembly 	1	1
B	Case 	1	1
C	Small Drawer Box (inserted) 	1	1
D	Medium Drawer Box (inserted) 	1	1
E	Large Drawer Box (inserted) 	1	1
F	Small Drawer Face (installed) 	1	1
G	Medium Drawer Face (installed) 	1	1
H	Large Drawer Face (installed) 	1	1
I	Pull-out (installed) 	0	1
J	Push Latch (attached) 	0	1
K	#5 x 5/8" Flat Head Screw (inserted) 	0	2
L	Small Pull (attached) 	3	3
M	#8 x 1-1/4" Machine Screw (installed) 	6	6
N	Drawer Slides (installed sets) 	3	3
O	#6 x 1/2" Philtruss Screw (inserted) 	18	18
P	#6 x 3/4" Philtruss Screw (inserted) 	18	18
Q	#8 x 7/8" Lo-Profile Screw (inserted) 	12	12
R	T-Nut (inserted) 	2	2
S	Small Adjustable Glide (installed) 	2	2
T	#8 x 1-1/4" Pan Head Screw (inserted) 	4	3
U	#8 x 1-3/4" Pan Head Screw (inserted) 	0	6
Y	#8 x 1-1/4" Black Screw (inserted) 	6	6
TR	Furniture Tipping Restraint	1 set	1 set

1108 shown in the illustrations.

# 1106GBCH and 1108GBCH Cascade Nightstand

Tool Required: Phillips Screwdriver

---

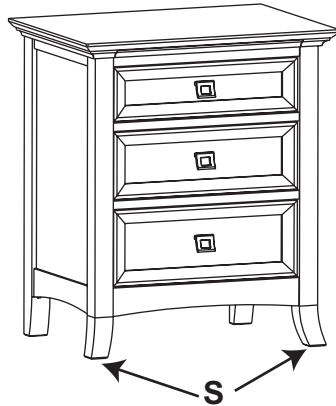

Fig. 1

1. Place the unit at its final destination. Rotate the Small Adjustable Glides (S) on the bottoms of the front legs until the unit is level. See Figure 1.
- 

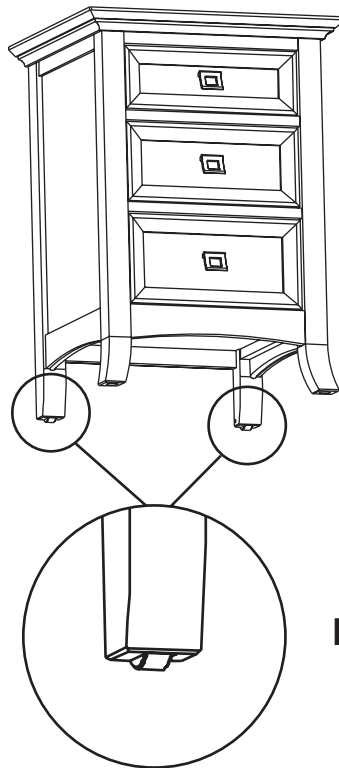
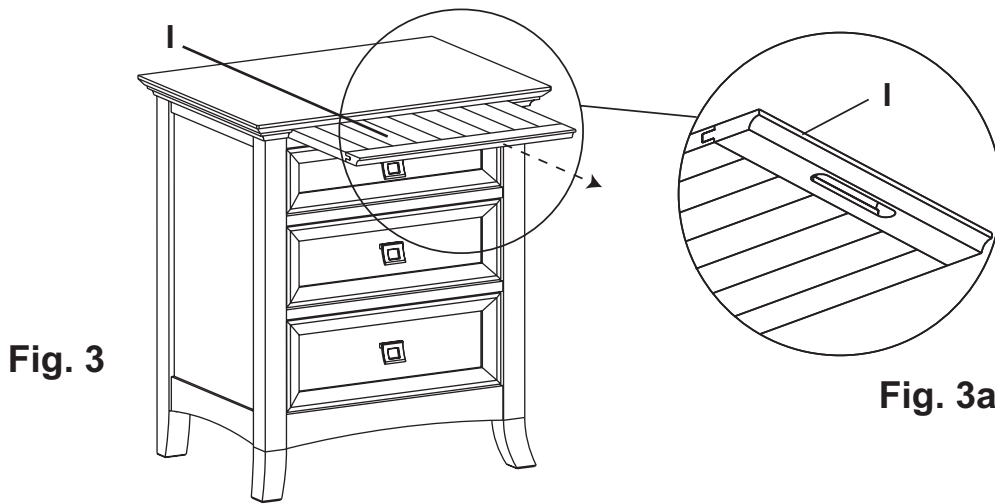

Fig. 2

Fig. 2a



2. A great feature of these nightstands is they have wheels on their two back legs. Now you can easily vacuum underneath or move one of these units when you need access to the drawers nearest to the headboard in a Whittier storage bed. To move this unit, be sure to remove any articles sitting on the top. Lift the front of the piece until the two forward legs are off the floor. Roll it away. See Figures 2 and 2a.



3. The 1108 Cascade 3-Drawer Nightstand features a Pull-out (I) that is located above the three drawers. To access this feature, push firmly on the end of the pull-out. This releases the Push Latch. Grab on to the underside hand groove and gently pull forward. To close the pull-out, gently push it back into the Case until it comes into contact with the Push Latch. See Figures 3 and 3a.

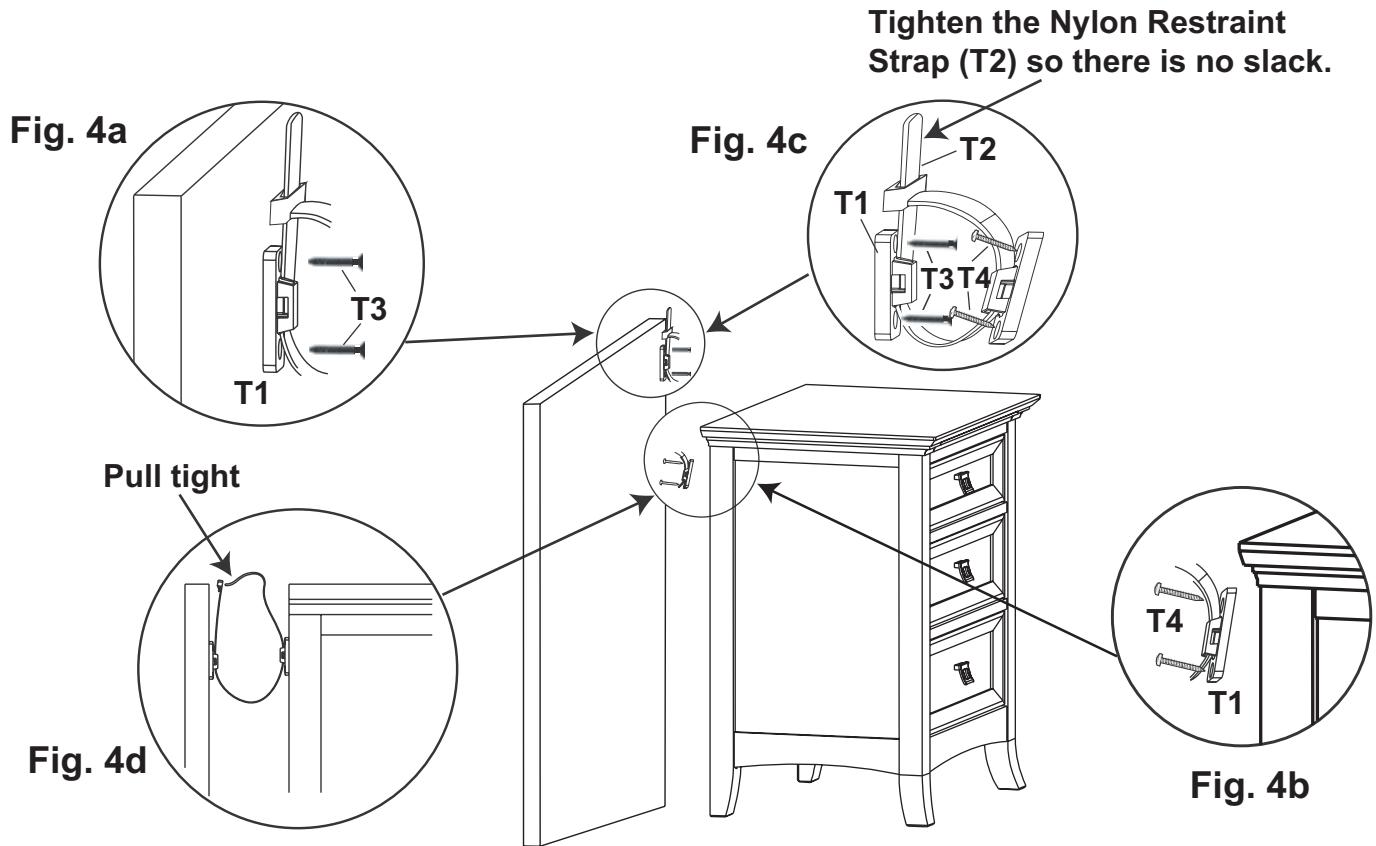

**Tipping restraint:**

4. Locate a stud in the wall behind the unit. Attach a Clip (T1) to the wall stud with two #8 x 2" Black Screws (T3). See Figure 4a. Attach the second clip to the unit with two #8 x 1" Pan Head Screws (T4). See Figure 4b. Connect the two clips with the Nylon Restraint Strap (T2). **Pull the Nylon Restraint Strap (T2) tight so there is no slack.** See Figures 4c and 4d. If you cannot locate a stud, purchase the proper wall attachment hardware for your type of wall and secure the unit.

***Unless specifically designed to accommodate, do not set a TV or any other heavy object on top of this product.***